



www.dtausagroup.com
The Choice of Professionals



Tiling Tools & Accessories

Catalog Edition 8



USA

P 925-371-7101

F 925-905-3063

E sales@dtausagroup.com

230 South Vasco Rd.

Livermore, CA 94551



The Choice of Professionals

DTA reserve the right to change product specifications without notice. Products may vary from pictures shown.



The Choice of Professionals

DTA Tiling tools are designed and manufactured for use by tiling professionals and handypersons. They cover a wide range of indispensable products that make tiling both easier and more profitable. These range from trowels to spacers, silicones to grout scrubbers. For example, DTA trowels are available in various steels with a variety of notches and handles at many price points. DTA also offers general hand tools and power tools as well as handy gadgets that help make tiling easier. If you have any project that requires tiling DTA will have a tool to help you.



TILING TOOLS & ACCESSORIES	4
Prep Tools	4
Setting Tools	10
Grouting and Clean Up	19
Lippage System & Spacers	27
Safety and Surface Protection	33
TILE CUTTERS & DIAMOND CUTTING	38
Boss Professional Diamond Blades	38
Hole Cutters	44
Cyclone Series	47
DTA Grinding And Abrasive Wheels	49
Tile Cutters	57
FORMAT TOOLS	61
DRAINS	66
PVC Drain	67
Shower Drain	67
PROFILES & TRANSITIONS	68
Profile Selection	68
Edge Profile	69
Transiton Profile	79
MERCHANDISING	82

INDEX

PREP TOOLS

5" Heavy Duty Wall / Floor Scraper

- Ideal for cleaning glass, mirrors and tiles
- Removes wallpaper, paint, small amounts of grout, adhesive and plaster from concrete floors
- Designed for wall and floor tiles
- Steel construction

Code	Size	Pk Qty
5WFS	5"	4
5WFSB	5" Replacement Blade	10



4" Heavy Duty Wall / Floor Scraper

- Ideal for cleaning glass, mirrors and tiles
- Removes wallpaper, paint, small amounts of grout, adhesive and plaster from concrete floors
- Designed for wall and floor tiles
- Steel construction

Code	Size	Pk Qty
4LS16	4"	5
4LS16B	4" Replacement Blade	20



Heavy-Duty Floor Scraper

- Heavy-duty construction
 - Effectively cleans excess plaster and adhesive from cement before tile laying
- REPLACEMENT BLADE - FSHD200RB - FSHD300RB

Code	Size	Pk Qty
FSHD200	8"	6
FSHD300	12"	6



Extendable Floor Scraper

- Extendable Floor Scraper 38" - 67"
 - Sturdy Construction
 - Cushion Grip handle for comfort
- REPLACEMENT BLADE - FS1700RB

Code	Size	Pk Qty
FS1700	8"	5
FS1700RB	8" Replacement Blade	10



4" Deluxe Wall Scraper

Code: 4DWS

Pk Qty: 12

- Ideal for removing tiles from wall displays, showers and splashbacks
- Rubber contoured handle with steel cap for extra strength
- Steel blade 3/64" thick, bent for extra leverage



Floor Scraper 6"

6" STEEL BLADE

- Effectively cleans excess plaster and adhesive from cement before tile laying

REPLACEMENT BLADE - FS150RB

Code	Size	Pk Qty
FS150	6"	6
FS150RB	6" Replacement Blade	6



Mortar Scraper

Code: **68-035S**

Pk Qty: **6**

- Steel blades are great for cleaning off excess mortar
- Size: 4" x 10"



Paint Scraper

- For cleaning excess adhesive or plaster from small surfaces before plaster from small surfaces before tile laying

Code	Size	Pk Qty
2PS	2"	12
3PS	3"	12
4PS	4"	12



Fine Nylon Chalk Line Set

Code: **CLFN**

Pk Qty: **10**

- Impact resistant ABS case
- Handle can be locked in any position for added adjustability
- 100' long fine nylon string
- Includes 115g of fine blue chalk IRWB Chalk Line Refill



Cement Board Screws

- Designed for fixing cement sheets and plasterboard to timber substrates
- Hi-lo thread, Spade / Spoon point, hardened
- Corrosion resistant ceramic coating

Code	Size	Pk Qty
SCR114	1-1/4" Screws - 200/box	20
SCR158	1-5/8" Screws - 200/box	20
SCR114B	1-1/4" Screws - 800/bucket	8
SCR158B	1-5/8" Screws - 800/bucket	8



Shower Drain Frames and Screens

- Stainless steel corrosion resistant construction
- Square frame for easy tile installation

Code	Size	Pk Qty
DSF	Stainless Drain Frame	10
DSR	Stainless Drain Ring	10
DSS	Stainless Drain Screen	10



Fox Tail Brush

Code: **TBR**

Pk Qty: **6**

- Flagged-Tip bristles for sweeping up the finest Tile and Stone dust



Toilet Wax Rings

- Specification: 5.5" x 3.75" x 1"
- For 3" or 4" waste lines

Code	Description	Pk Qty
WRK	With plastic flange and bolts	20
WRF	With plastic flange only	20
WR	Without flange	20



DTA Box Screed

Code	Size	Pk Qty
DTASE018	DTA Box Screed Straight Edge 18"	1
DTASE024	DTA Box Screed Straight Edge 24"	1
DTASE030	DTA Box Screed Straight Edge 30"	1
DTASE036	DTA Box Screed Straight Edge 36"	1
DTASE048	DTA Box Screed Straight Edge 48"	1
DTASE057	DTA Box Screed Straight Edge 57"	1

Code	Size	Pk Qty
DTASE072	DTA Box Screed Straight Edge 72"	1
DTASE084	DTA Box Screed Straight Edge 84"	1
DTASE096	DTA Box Screed Straight Edge 96"	1
DTASE120	DTA Box Screed Straight Edge 120"	1
DTASESET	DTA Box Screed Straight Edge 18", 24", 30", 36", 57", 72"	1

- Designed for screeding and leveling tile
- Durable, hard, powder coated aluminum construction

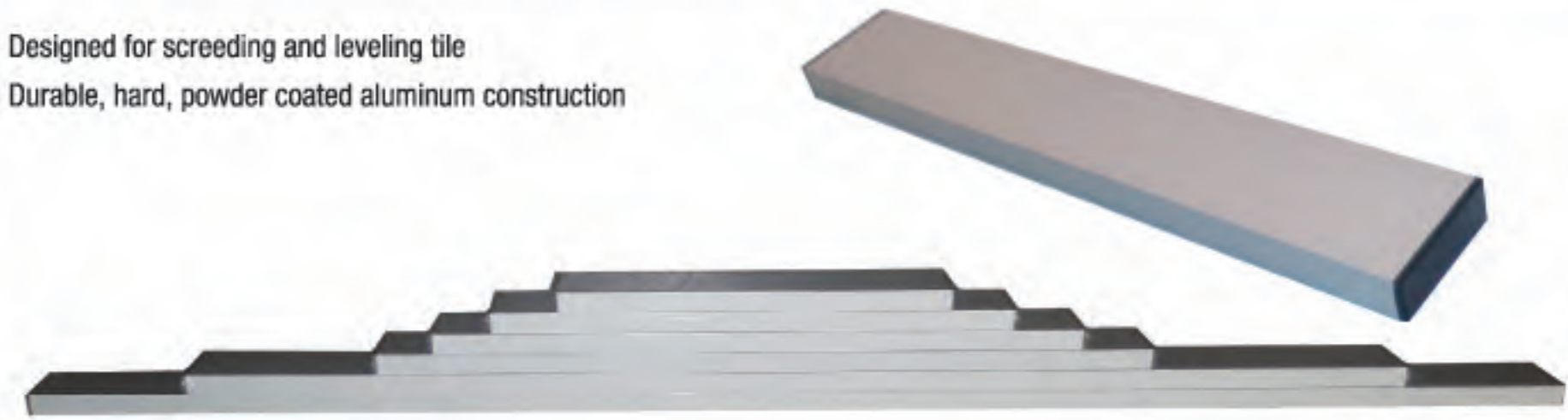

DTA L Edges

- Designed for screeding and levelling tile
- Durable aluminum construction

Code	Size	Pk Qty
ALES24	24" x 3" x 1"	1
ALES30	30" x 3" x 1"	1
ALES36	36" x 3" x 1"	1
ALES48	48" x 3" x 1"	1
ALES57	57" x 3" x 1"	1
ALES72	72" x 3" x 1"	1
ALES84	84" x 3" x 1"	1
ALES96	96" x 3" x 1"	1
ALSS	18", 24", 30", 36", 57", 72"	1

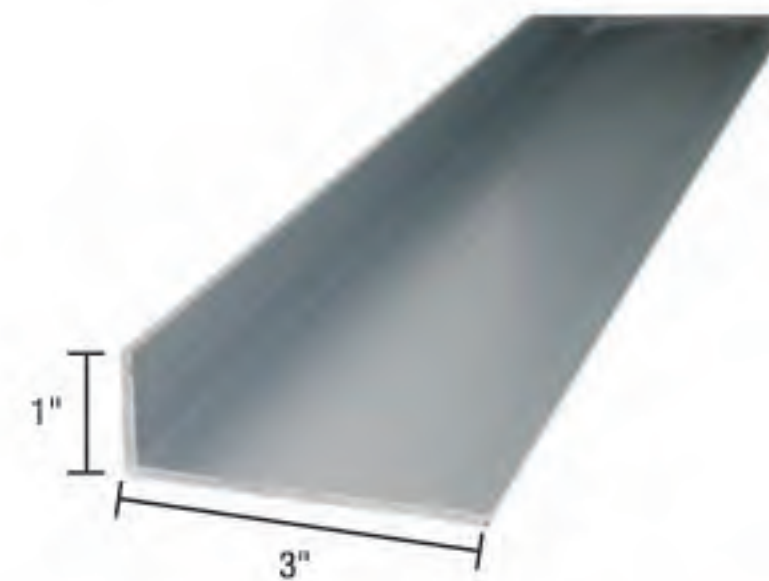

Adjustable Tile Levelling Support

Code: **DTATS**

Pk Qty: **8**

- Trigger adjustment for accurate levelling
- Quick release button
- To be used with straight edge
- Adjustable from 4.5" - 12.5"



PVC Contour Gauge 10"

Code: **PCG10**

Pk Qty: **10**

- Durable PVC contour gauge
- Easy to use, simply press the gauge into the area to be measured
- Two gauges can be combined for extra length





Masking Tape

Color	Code	Size	Qty	
Blue 1"	TPB1	1" x 180ft Blue Painters tape	48	
Blue 1.5"	TPB112	1.5" x 180ft Blue Painters tape	48	
Blue 2"	TPB2	2" x 180ft Blue Painters tape	48	
Masking 1.5"	TPW112	1.5" x 180ft White Masking tape	48	
Masking 2"	TPW2	2" x 180ft White Masking tape	48	
Duct 2"	TPD2	2" x 180ft Duct tape	48	
Red 2"	TPR2	2" x 180ft Red Vinyl tape	48	
Green 1.5"	TPG112	1.5" x 180ft Green Masking tape	48	
Green 2"	TPG2	2" x 180ft Green Masking tape	48	
Mesh 2"	MJP2-77	2" x 77ft Mesh Joint tape	200	
Mesh 2"	MJP2-302	2" x 302ft Mesh Joint tape	24	

PREP TOOLS



Pro Levels

Code	Size	Pk Qty
LVL600	24"	1
LVL800	32"	1
LVL1000	40"	1
LVL1200	48"	1
LVL1800	72"	1

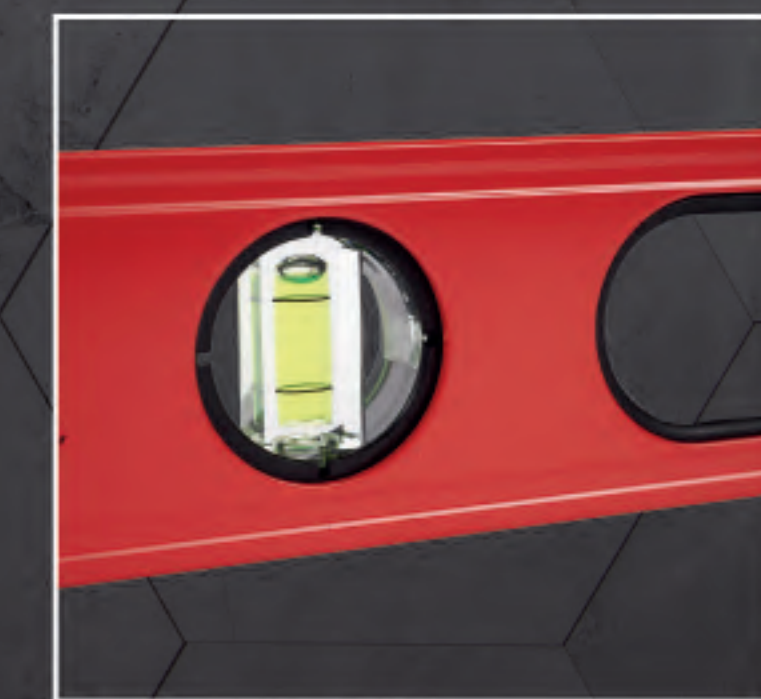

PREP TOOLS

- ✓ Aluminium
- ✓ Magnified horizontal vial
- ✓ Shock absorbing bi-material end caps
- ✓ Ergo grip non-slip handles



TIGER TROWEL

Tile Bedding Down Process



Code: USTR
PK Qty:5



VIDEO DEMO

1. To view the video, download any QR Code Reader App. on your smart phone.
2. Scan the QR Code to watch video.

- ✓ Suitable for tiles 12" x 12" and over
- ✓ Contoured soft grip handle
- ✓ High carbon spring steel blade



Stainless Steel Plasters Trowel

Code: SSTRPT

Pk Qty: 5

- Plastering trowel
- Stainless steel blade
- Durable die cast aluminum with contoured handle
- Rotatable handle



Notched Margin Trowel

- Margin trowel for applying adhesive to the back of tiles
- Hardened steel construction with contoured handle

Code	Size	Pk Qty
47-311S	1/4" x 1/4" Square Notch	12
47-308S	1/4" x 3/16" V Notch	12



DTA Splash Trowel

- Splash trowel for mixing and applying adhesive
- Hardened spring steel construction
- Comfortable contoured rubber handle

Code	Size	Pk Qty
ST140	5-1/2"	5
ST200	8"	5



DTA Margin Trowel

- Margin trowel for applying adhesive to the back of tiles
- Hardened steel construction with contoured wooden handle

Code	Size	Pk Qty
005	5"	12
006	6"	12
008	8"	12



Adhesive Spreader

- Strengthened steel square notched scraping edge for wall tiles
- Comfortable plastic handle
- Applies adhesive around vanities

Profile	Code	Size	Pk Qty
1/4"	4PSN	4"	12
5/16"	4PSN8	4"	12
3/8"	4PSN10	4"	12



Gauging Trowels

- Used for applying adhesive
- Hardened spring steel construction
- Comfortable contoured rubber handle

Code	Size	Pk Qty
GT017	7"	12
GT018	8"	12



Tiger Trowel

Code: USTR

Pk Qty: 5

- Suitable for tiles 12" x 12" and over
- Contoured soft grip handle
- High carbon spring steel blade



BOSS Professional Stainless Steel Notch Trowels

- High Grade 4.5" x 11" Stainless Steel Blade
- Contoured rubber handle
- The ultimate in comfort and durability
- PK Qty: 5



Codes	Notch	Notch Size
SSTR3	SQ	1/8" x 1/8" x 1/8"
SSTR4	SQ	5/32" x 5/32" x 5/32"
SSTR6	SQ	1/4" x 1/4" x 1/4"
SSTR8	SQ	5/16" x 5/16" x 5/16"
SSTR10	SQ	3/8" x 3/8" x 3/8"
SSTR12	SQ	1/2" x 1/2" x 1/2"
SSTR106	SQ	3/8" x 1/4"
SSTRU3	U	1/8" x 1/8" x 1/8"
SSTRU4	U	5/32" x 5/32" x 5/32"
SSTRU6	U	1/4" x 1/4" x 1/4"
SSTRU8	U	5/16" x 5/16" x 5/16"
SSTRU10	U	3/8" x 3/8" x 3/8"
SSTRU12	U	3/4" x 3/4" x 3/4"
SSTRV5	V	3/16" x 5/32"
SSTRV6	V	1/4" x 3/16"

DTA Professional Carbon Steel Notch Trowels

- High Grade 4.5" x 11" Spring Steel Blade
- Contoured rubber handle
- The ultimate in comfort and durability
- PK Qty: 5



Codes	Notch	Notch Size
BST1.5	SQ	1/16" x 1/16" x 1/16"
BST3	SQ	1/8" x 1/8" x 1/8"
BST6	SQ	1/4" x 1/4" x 1/4"
BST10	SQ	3/8" x 3/8" x 3/8"
BST12	SQ	1/2" x 1/2" x 1/2"
BST25	SQ	3/32" x 3/32" x 3/32"
BST45	SQ	3/16" x 3/16" x 3/16"
BST106	SQ	3/8" x 1/4"
BST6-3	SQ	1/8" x 1/4" x 1/4"
BSTU6	U	1/4" x 1/4" x 1/4"
BSTU106	U	1/4" x 3/8" x 1/4"
BSTU325	U	1/8" x 3/32" x 1/8"
BSTU345	U	1/8" x 3/16" x 1/8"
BSTV15	V	1/16" x 1/16" x 1/16"
BSTV25	V	3/32" x 3/32" x 3/32"
BSTV454	V	3/16" x 5/32"
BSTV3-16	V	1/4" x 3/16"
BSTV5-16	V	5/16" x 1/4" x 1/16"

Galvanized Economy Notch Trowels

- 4.5" x 9" Galvanized Steel Blade
- Comfortable plastic handle
- Lightweight and durable
- PK Qty: 5



Codes	Notch	Notch Size
EAT15A	SQ	1/16" x 1/16" x 1/16"
EAT3A	SQ	1/8" x 1/8" x 1/8"
EAT4A	SQ	5/32" x 5/32" x 5/32"
EAT6A	SQ	1/4" x 1/4" x 1/4"
EAT8A	SQ	5/16" x 5/16" x 5/16"
EAT10A	SQ	3/8" x 3/8" x 3/8"
EAT12A	SQ	1/2" x 1/2" x 1/2"
EATU1512A	U	1/16" x 1/32" x 5/64"
EATV454A	V	3/16" x 5/32"
EATV645A	V	1/4" x 3/16"

Notch Patterns

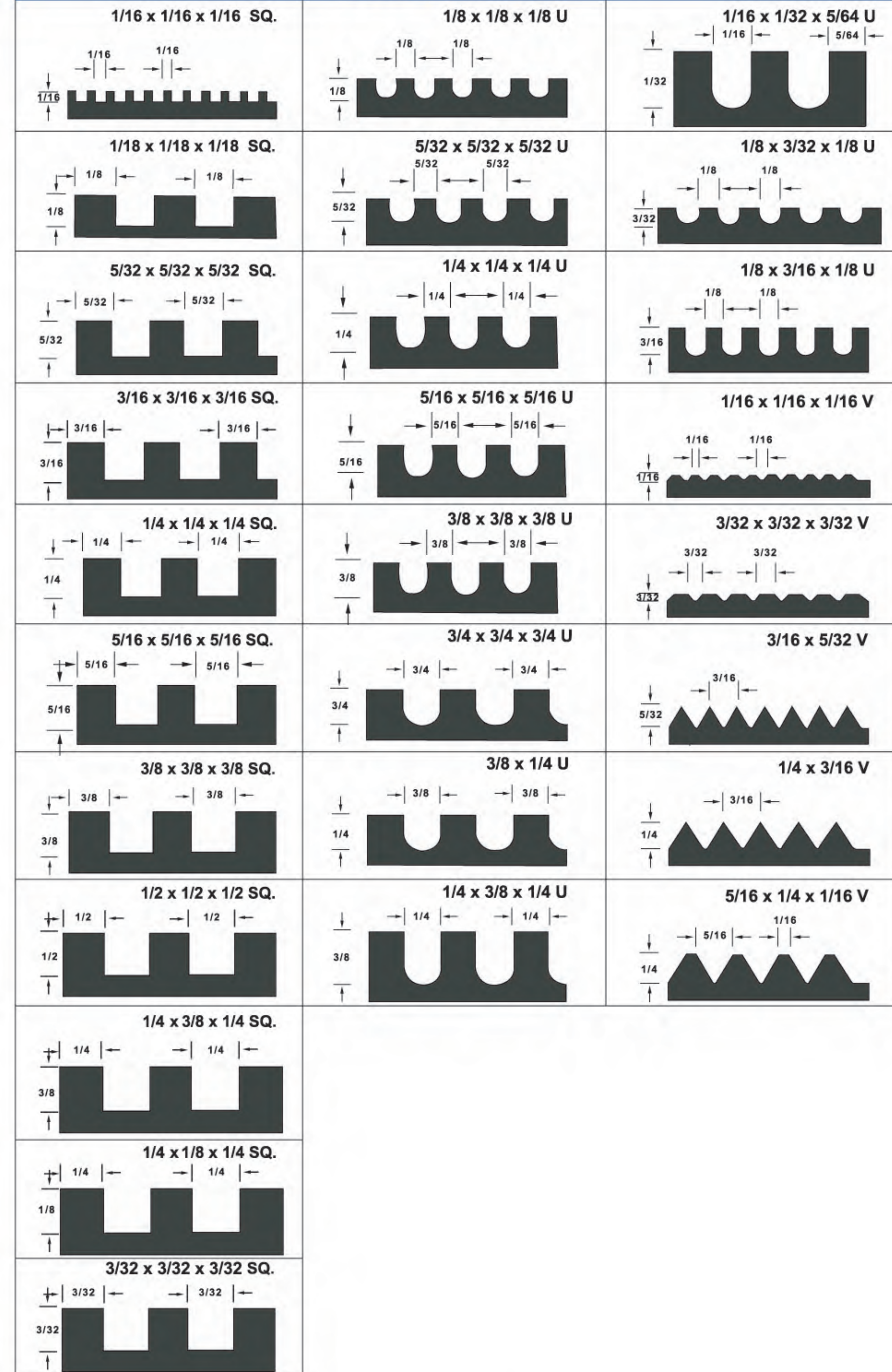

5 Gallon Bucket

Code: 1821
Pk Qty: 1

- Ideal for thinset and grouting mixing
- All purpose bucket



Bucket Dolly with Wheels

Code: BDOLLY
Pk Qty: 1

- 5 castor wheels
- 3 castor wheels with brake
- Suitable for 20L buckets
- Durable plastic construction
- Ideal for moving adhesive around site



Small Tools

- Small tool for applying adhesive in hard to reach areas
- Hardened steel construction Useful for cleaning excess grout from between tiles

Code	Size	Pk Qty
R314-1	1"	10
R314-34	3/4"	10



Wood Float

- Made from long lasting Hardwood

Code	Size	Pk Qty
WF14	14"	6
WF16	16"	6



Hawk

- Aluminum hawk with soft grip handle

Code	Size	Pk Qty
HAWK13	13" x 13"	5

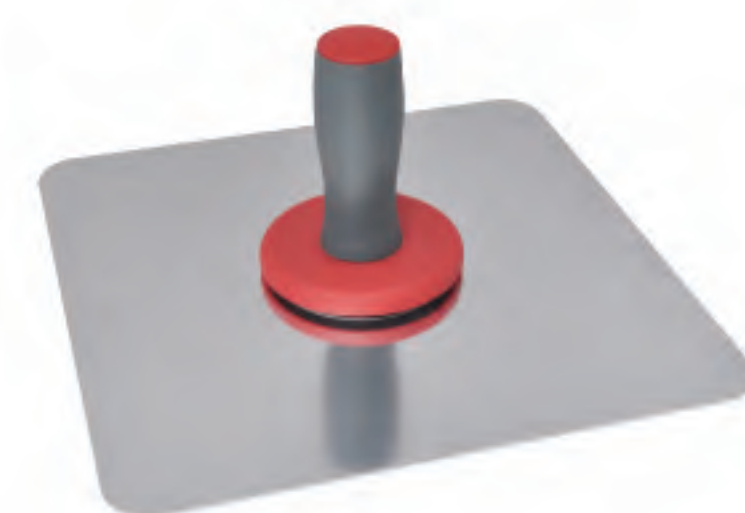

Hand Support for Tiling

Code: HNDSP
Pk Qty: 10

- Ideal for support while applying adhesive
- Soft TPR handle
- Rubber feet for extra grip



Mortar Board Stands

Code: 2423
Pk Qty: 1

- Aluminum Mortar Board Stand
- Light Weight and Rust-proof



Hand Tile Cutter

- Hardened tungsten carbide jaws
- Cuts small curved sections in tiles

Code no.	Description	Jaw View	Pk Qty
09-011	Curved jaw nipper		6
09-012	Straight jaw nipper		6



Rotary Hand Tile Cutter

Code: 09-134
Pk Qty: 6

- Lightweight hand tile cutter
- Tungsten carbide scoring wheel
- Breaker arm for tile cutting
- Ideal for ceramic wall tiles
- Perfect for small cutting jobs



Twin Wheel Mosaic Cutter

Code: TWMC
Pk Qty: 6

- Ideal for cutting glass mosaics and tiles
 - Comfortable handle
- REPLACEMENT WHEEL - TWMCWSW



Combination Straight and Curved Jaw Hand Tile Cutter

- Curved/Straight jaw nipper
- Tungsten carbide tipped jaws
- Spring loaded handle

Code no.	Description	Jaw View	Pk Qty
09-013	Curved jaw nipper		6
09-268	Straight jaw nipper		6



Quarry Tile Nipper

Code: 09-217
Pk Qty: 6

- Extremely robust heavy-duty nipper
- Oversized tungsten carbide tipped jaws
- Lengthened handles (250mm)
- Suited to cut quarry and large tiles



Mosaic Glass Cutter

Code: MGC
Pk Qty: 12

- Cuts up to 3/8" thick glass
- Handle has oil reservoir with tungsten carbide cutting wheel
- Oil prevents glass fragmentation
- Includes oil refiller
- Oil not included



Flat Tile File

Code: FTF

Pk Qty: 24

- Coarse and fine filing surfaces
- Tungsten carbide construction
- Smooths rough tile edges



Flat Sheet File

Code: FSF

Pk Qty: 24

- Tungsten carbide mesh construction
- Smooths rough floor and wall tile edges



Rod Saw

- Tungsten carbide construction
- Easily attaches to a saw handle
- Fits any standard hacksaw
- Cuts different shapes in tiles

Code	Size	Pk Qty
RS6	6"	24
RS12	12"	24



Tile Saw 6"

Code: 1115

Pk Qty: 12

- Designed to accommodate 6" rod saws
- Steel frame construction
- Comfortable contoured rubber handle
- Cuts different shapes and holes in tiles
- Complete with blade

REPLACEMENT BLADE - RS6



Hacksaw Grit Edge 12"

Code: HS12

Pk Qty: 24

- Tungsten carbide blade edge
- Ideal for straight cutting tiles
- Fits any standard hacksaw



DIY Tile Scriber

Code: 09-182

Pk Qty: 24

- Tungsten carbide tip for easy tile glaze scoring
- Includes a protective storage cap
- Simple to use



Trade Tile Scriber

Code: 09-176

Pk Qty: 12

- Tungsten carbide tipped scoring blade
- Lightweight construction
- Contoured handle for comfortable operation



Combination Tile Scriber / Grout Remover

Code: 22-291CG

Pk Qty: 12

- Cutters have a tungsten carbide scoring wheel and pins for breaking tiles
- Grout remover comes with two tungsten carbide tipped blades in handle



Score & Snap Knife

Code: 09-278

Pk Qty: 12

- Comes with two tungsten carbide tipped blades
- Designed to cut cement sheeting or ceramic tiles



Retractable Utility Knife

Code: DTARK

Pk Qty: 10

- 10 blade utility knife
 - Non-slip ergonomic grip
 - Push button to release old blade
 - Slide back function to engage new blade
- REPLACEMENT BLADES - UBD100



Utility Knife Blades

Code: UBD100

Pk Qty: 50

- Pack of 100 spare blades
- Designed to suit.



Single Edge Razor Blades

Code: SERB100

Pk Qty: 12

- Single Edge Razor Blades
- #9 Single Edge Razor Blades
- Made in USA



China Marker

- Can be used on polished shining surfaces

Color	Code	Pk Qty
Black / Yellow	CM2	12
Black	CMB12	12
Red	CMR12	12
Yellow	CMY12	12



DTA Pencils - 6 Pack

Code: DTAPENCIL

Pk Qty: 20

- Ideal for marking Concrete, Wood, Drywall and tiles for cutting



Economy Paint Brush

Code: PB100E

Pk Qty: 24

- 4" economy paint brush
- Ideal for applying sealers and waterproofing agents



New Pro. Tape Measures

Code: DTATM25

Pk Qty: 6

- Heavy-duty, professional rubber cased construction
- 25ft blade, belt clip, thumb lock, wrist strap and retractable blade.



White Rubber Mallet 1.2lb

Code: RM2W

Pk Qty: 6

- Designed to easily embed larger tiles into adhesive and screed
- White rubber protects the surface of tiles from damage and marks





Rubber Suction Cup

Code: DTARSC

Pk Qty: 24

- Heavy duty rubber
- 3.5" diameter
- 33 LBS lift capacity



PVC Suction Cup

Code: DTASC

Pk Qty: 6

- 66 LBS lift capacity, heavy-duty PVC suction cup
- Ideal for carrying marble, granite or glass tiles
- Ideal for adjusting misplaced or removing cracked tiles



Aluminum Suction Cup

Code: DTAMSC

Pk Qty: 12

- 88 LBS lift capacity, heavy-duty aluminum construction
- Ideal for carrying marble, granite or large ceramic tiles
- Ideal for adjusting misplaced or removing cracked tiles



Aluminum Dual Suction Cup

Code: DTASC2

Pk Qty: 6

- Ideal for carrying heavy tiles such as marble, granite and large ceramic tiles
- Can be used on any clean smooth surface
- Carries up to 175 LBS
- Ideal for adjusting misplaced or removing cracked tiles
- Made of heavy duty aluminum



Heavy Duty Vacuum Suction Cup

Code: DTAVSC8

Pk Qty: 1

- 8" vacuum suction
- Pump action with quick release lever
- 264 LBS capacity



Heavy Duty Metal Vacuum Suction Cup

Code: DTAMVSC8

Pk Qty: 1

- 8" Vacuum Suction Cup
- Metal Handle
- Pump Action with quick release lever
- 286 LBS capacity



Grouting and Clean-Up



BOSS Mixer

Code: M1200MK2

Pk Qty: 1

- 1200 watt motor
- Variable speed control
- 2 gear transmission
 - 1: 150 - 300 rpm
 - 2: 300 - 650 rpm
- Soft start and more torque



The Choice of Professionals

AS/NZS 60745.1:2009 Approval

BOSS Twist Mixer for M1200

Code: **MH2140**
Pk Qty: 4

- 5-1/2" Twist Mixing Paddle
- Works material upwards
- Best for grout



BOSS Spiral Mixer for M1200

Code: **MH3140**
Pk Qty: 4

- 5-1/2" Spiral Mixing Paddle
- Works material both upwards and downwards
- Best for mortar



Chuck Adapter

Code: **M1200CHUCK**
Pk Qty: 1

- 1200 watt motor
- Variable speed control
- 2 gear transmission
 - 1:150 - 300rpm
 - 2:300 - 650rpm
- Soft start and more torque



BOSS Plaster Mixer for M1200

Code: **MH4220**
Pk Qty: 10

- 8-5/8" Plaster Mixing Paddle



Glue / Paint Mixer

- Available in Small, Medium and Large
- Nickel plated steel construction

Code	Size	Pk Qty
GPMS	3-5/32"(D) x 5/16"(S) x 18"(L)	12
GPMM	4"(D) x 3/8"(S) x 17-3/8"	6
GPML	5-1/8"(D) x 3/8"(S) x 20-1/2"(L)	4



Economy Glue Mixer Small

Code: **AGL**
Pk Qty: 5

- **3" DIAMETER with 5/16" DIAMETER SHAFT**
- Powder coated steel construction



Egg Beater Mixer

Code: **82-171-28**
Pk Qty: 6

- Perfect for mixing thinset and mud
- Chrome Steel Construction

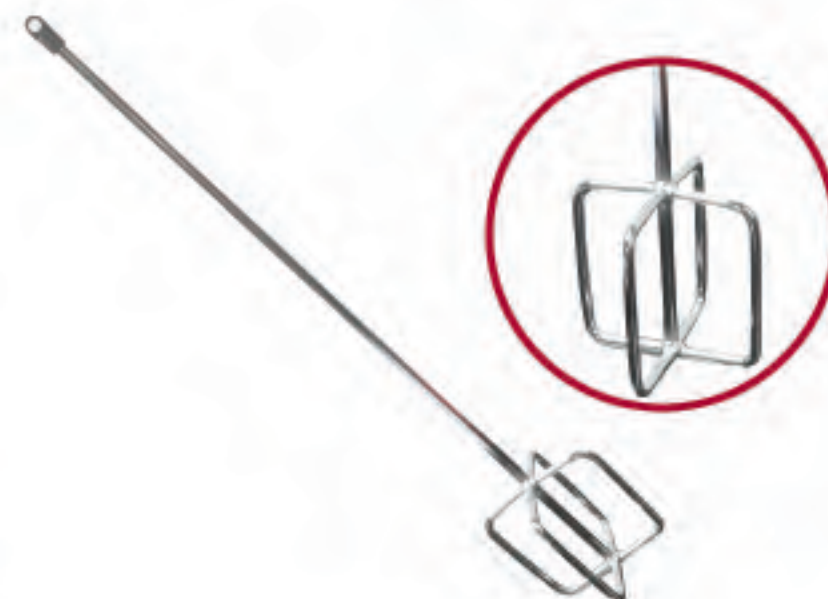

Pro Solid Rubber Grout Float

Code: **PRO-GF9**
Pk Qty: 6

- 9.5" Flexible Float
- Soft Flexible Edge Squeegees grout from tile surface making clean up faster and easier



Gum Rubber Grout Floats

Code: **DTARF9**
Pk Qty: 12

- 4" x 9.5" Grout Float with Foam pad and Gum Rubber Base

Code	Size	Pk Qty
DTARF9	4" x 9.5"	12



Gum Rubber Grout Floats

Code: **DTARF12**
Pk Qty: 12

- 4" x 12" Grout Float with Foam pad and Gum Rubber Base



Tapered Rubber Float

Code: **63030456**
Pk Qty: 12

- 3" to 4" x 12" Tapered Grout Float with foam pad and Gum Rubber Base



Epoxy Grout Float

Code: **GEF**
Pk Qty: 6

- 4" x 9.5" hard green rubber float designed for Epoxy Grout



Margin Float

Code: **36-045S**
Pk Qty: 10

- 2" x 6" Margin Grout Float with foam pad and Gum Rubber Base protect for getting into tight space





Grout Bag Vinyl Plastic Tip

Code: 68-219

Pk Qty: 20

- 23-1/2"
- With plastic tip

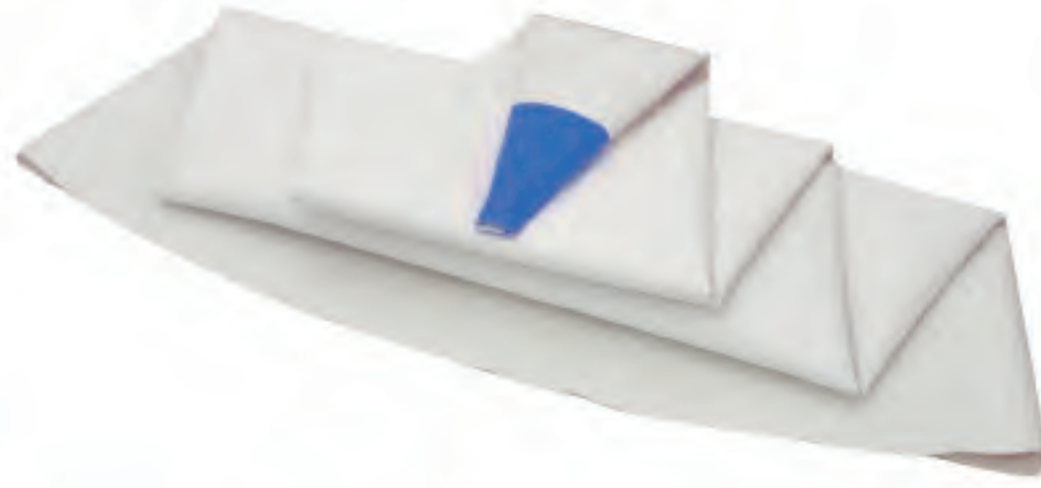

Grout Bag Heavy Duty Vinyl

Code: 68-213

Pk Qty: 20

- 23-1/2"
- Removable steel tip
- Used for grouting large joints or large tile without spreading grout over entire job



DTA Trade Grout Clean-Up System

Code: UYBWMTS

Pk Qty: 1

- DTA Grout Clean-Up System designed for ease and efficiency
- Includes:
 - 6 gallon bucket with castor wheels
 - Double roller and grate
 - 1 small clip on sponge
 - 1 large clip on sponge with handle

Code No	Description	Qty
UYBWM GRATE	Plastic Grate For Uybwmt	1
UYBWMBU	6 gal Plastic Bucket	1
UYBWMC	Color Carton For Uybwmt	1
UYBWMR	Spare Rollers For Uybwmt	1
UYBWMW	Grey Wheels For Uybwmt(Set Of 2)	1
UYBWML	Support legs For Uybwmt(Set of 2)	1



Clip on Sponge and Handle

- Hydro Sponge for extra absorption
- 4 Clips for extra strength
- Reusable handle

Code	Product	PK Qty
CLSP	Hydro Sponge 13-3/8" x 5-1/2" x 1-5/8"	10
CLSPS	Hydro Sponge 11" x 5-1/8" x 1-3/16"	10
CLSPH	Handle	10



Velcro Sponge Foam and Handle for Grout Clean-Up System

- Velcro Sponge suited to UYBWM TDA Trade Grout Clean-Up System
- Segmented design allows efficient rinsing and grout removal

Code	Product	Pk Qty
DTAVSP	Velcro Sponge Foam	12
DTAVH	Velcro Handle	12
DTAVSPD	Deluxe Velcro Hydro Sponge	12
VDSH	Deluxe Velcro Hydro Sponge and Handle	12



Yellow Tilers' and Slaters' Sponge

- Ideal for cleaning large tiled and slate areas after grouting
- Hydro sponge

Code	Size	Pk Qty
TSS128	12"(L) x 4"(W) x 2"(D)	16



Microfiber Sponge

- Hydro sponge for high absorption
 - Microfibre is ideal for removing grout haze after drying
- DIMENSIONS: 8"(L) x 6"(W) x 2"(D)

Product	Code	Barcode	Pk Qty
Single	MFS75	9314942666240	32



Hydro Sponge

- Ideal for cleaning large tiled areas after grouting

Code	Product	Size	Pk Qty
DTALPS	Xlarge Sponge	7-1/2"(L) x 5-1/4"(W) x 2"(D)	400
DTALPSE-250	Xlarge Sponge	7-1/2"(L) x 5-1/4"(W) x 2"(D)	250
DTALPS-30	30pcs Pack	7"(L) x 5-1/8"(W) x 2"(D)	30
DTALPSE-6	Pro Pack	7"(L) x 5-1/8"(W) x 2"(D)	6
DTALPSE	Individual Pack	7-1/2"(L) x 5-1/4"(W) x 2"(D)	1



DTA Scrubbing Sponge

- Ideal for cleaning large tiled areas after grouting
- Hydro sponge

Code	Size	Pk Qty
DTASS	6-3/8"(L) x 4-3/4"(W) x 2"(D)	8



DTA Epoxy Sponge

- Ideal for cleaning large tiled areas after grouting

Code	Product	Pk Qty
SP-5722	5"(L) x 3-3/8"(W) x 2"(D)	30
SP-5722L	6.5"(L) x 4.5"(W) x 2"(D)	30
SP-EPOXP	7.5"(L) x 5.5"(W) x 2"(D)	30





Cheese Cloth

- Made of 100% cotton
- lint free, unbleached

Code	Size	Pk Qty
CCL005	3ft x 15ft	30
CCL100	3ft x 300ft	20



Scouring Pad with Handle Triple pack

Code: **SCTP**
 Pk Qty: **25**

- Scouring set includes fine, medium and coarse pads
- Ideal for removing grout haze and wax from tiles



Doodlebug

Code: **DBV**
 Pk Qty: **12**

- Black nylon velcro system



Grout & Tile Brush

Code: **DTADGTB**
 Pk Qty: **144**

- Suitable for use on tiles and grout
- Soft grip handle



Grout Scrubber

Code: **DTAGSB**
 Pk Qty: **12**

- V shape to clean grout lines
- Soft rubber handle
- Use for tiled walls and floors



Grout Scrubber with Extendable Metal Handle

Code: **DTAGS**
 Pk Qty: **12**

- Effective brush for cleaning grout
 - Telescopic steel handle
 - Use for tiled walls and floors
 - Polymer cleaning head
- REPLACEMENT PARTS -
DTAGSH - Replacement Handle



Scouring Pad Fine

- Fine
- Designed for surfaces that are sensitive to scratching

Code	Size	Pk Qty
SCTPF	10" x 4-3/4" x 3/4"	100
SCTPF-10	10" x 4-3/4" x 3/4"	10

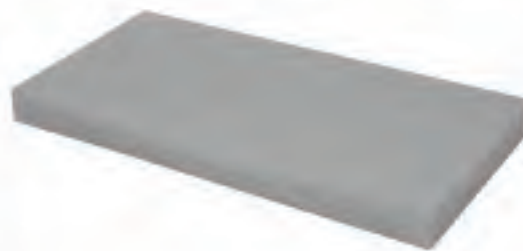

Scouring Pad Medium

Code: **SCTPM**
 Pk Qty: **100**

- Medium
- Ideal for removing grout residue from newly laid tiles



Scouring Pad Coarse

Code: **SCTPC**
 Pk Qty: **100**

- Coarse
- Ideal for removing old waxes and sealers from tiles



Silicone and Grout Maintenance Kit

Code: **SGMK**
 Pk Qty: **6**

- Contains silicone remover, grout remover, grout brush and universal handle



DTA Epoxy Sponge

Code: **BBRSH**
 Pk Qty: **6**

- Tough Brush for easy tool clean up



Wool Applicator with Handle

Code: **WAH**
 Pk Qty: **1**

- Highest grade merino wool applicator
- Durable timber handle and base
- Ideal for cleaning up excess grout and applying tile sealers
- Replacement Woollen Applicator:WAHRF



Handyman Grouter

Code	Size	Pk Qty
HG6	6"	24
HG9	9"	24

- Comfortable plastic handle with durable rubber grouting strip
- Easy to manoeuvre and ideal for small renovations



Trade Hand Grouter

Code	Size	Pk Qty
TG6	6"	24
TG9	9"	24
TG12	12"	24

- Larger plastic handle and rubber grouting strip for optimal comfort and durability
- Ideal for grouting larger tiled areas



Grout and Tile Brush

Code: **DTAGTB**
 Pk Qty: **10**

- Suitable for use on tiles and grout
- Contoured handle



Grout Sealer Applicator 6oz

Code: **GSA170**
 Pk Qty: **20**

- Adjustable nozzle for even flow
- Nylon bristles
- Refillable
- Quick and easy to clean



Grout Sealer Applicator W/1/8" & 1/4" Wheel

Code: **GSAW**
 Pk Qty: **20**

- For use with silicone, latex and acrylic based sealer and stains
- Includes two wheels 1/8" and 1/4" widths





Diamond Tile Grout Remover - Deluxe

Code: 22-291
Pk Qty: 12

- Twin blade design enables grout removal from wide or tight joints
 - Corrosion-resistant oxidised metal finish
 - Includes twin diamond blade
 - Angled handle for applying heavy pressure allows faster/safer cutting
- REPLACEMENT BLADES - 22-291DB



Tile Grout Remover - Economy

Code: 22-291E
Pk Qty: 12

- Twin blade design enables grout removal from wide or tight joints
 - Corrosion-resistant bright metal finish
 - Includes tungsten carbide tipped and steel toothed blade
 - Angled handle for applying heavy pressure allows faster and safer cutting
- REPLACEMENT BLADES - 22-291ESB



Economy Grout Remover

Code: DTAGRE
Pk Qty: 12

- Durable steel tooth blade (non-interchangeable)
- Ideal for small repair jobs



Combination Tile Scriber/Grout Remover

Code: 22-291CG
Pk Qty: 12

- Multi-function tile glass cutter and grout remover tool
- Small tungsten carbide scoring wheel and two steel pins for tile and glass breaking
- Grout remover comes with two tungsten carbide tipped blades
- Safe storage for second blade within PVC handle



Silicone Remover

Code: DTASR
Pk Qty: 12

- Dual action silicone remover allowing push or pull action
- Right angle blade for easy removal of silicone, acrylic and adhesive
- Rubber contoured handle



Silicone Applicators

Code: DTASA
Pk Qty: 24

- Quickly removes excess silicone
- Forms clean line



Economy Caulking

Code: DTACG
Pk Qty: 6

- Drip free skeleton



Trade Caulking Gun

Code: DTATCG
Pk Qty: 6

- Hold 10.5 oz tubes
- Heavy-duty steel construction with comfortable contoured handle
- Drip free



Sausage Caulking Gun

Code: TCG15
Pk Qty: 4

- No loss trigger to reduce run on
- Pressure release trigger
- Compatible for use with most sausage packs up to 20 oz in volume
- Maximum use of sealant with minimum waste
- Replacement nozzles available(TCG15SN)



Lippage System

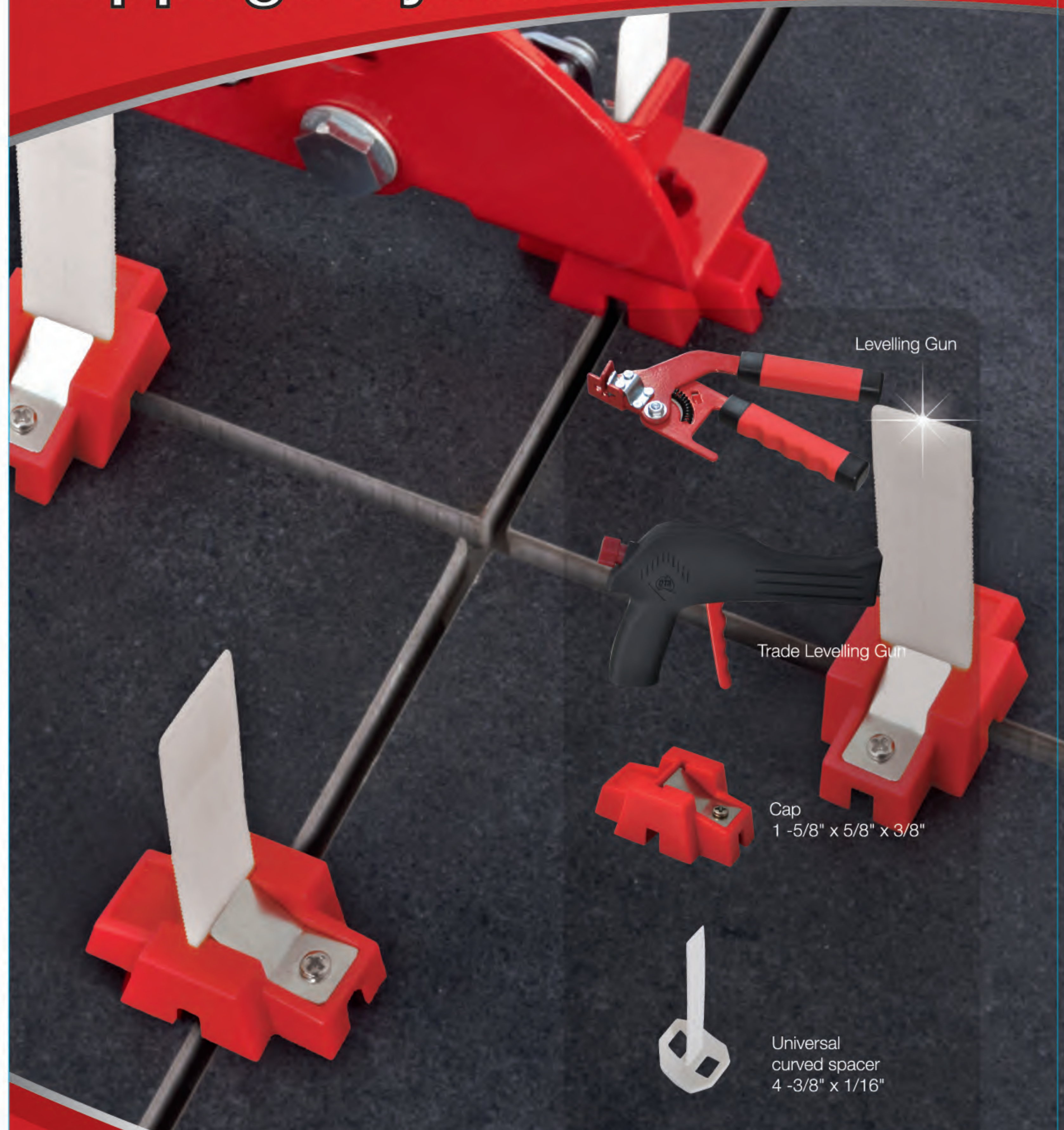

Levelling Gun

Trade Levelling Gun

Cap
1 -5/8" x 5/8" x 3/8"

Universal curved spacer
4 -3/8" x 1/16"

National Customer Service 925-371-7101



The Choice of Professionals

www.dtausagroup.com

Lippage Levelling Gun

Code: **LIPTL**

Pk Qty: **6**

- To be used with lippage system
- Ensures correct tension on spacer and cap
- Light weight durable construction
- Soft grip handle



Trade Lippage Levelling Gun

Code: **LIPTLT**

Pk Qty: **10**

Includes:

- 4 levels of tension and breaking point to ensure correct tension on cap and spacer
- Light weight durable construction



Lippage Starter Kit

Code: **LIPK100U**

Pk Qty: **6**

Includes:

- Lippage levelling gun
- 100 lippage caps
- 100 lippage universal spacers



Lippage Starter Kit

Code: **LIPK100**

Pk Qty: **6**

Includes:

- Lippage levelling gun
- 100 lippage caps
- 100 lippage standard spacers



Universal Lippage Spacer

- Can be used with other lippage systems on the market
- Made of nylon
- Curved base to allow for different tile thicknesses

DIMENSIONS - 4-1/4"(H) x 7/16"(W) x 5/64"(T)
Grout joint size: 1/16"



BAGS

Code	Pieces	Pk Qty
LIPSU100	100	6

BUCKETS

Code	Pieces	Pk Qty
LIPSU250B	250	4
LIPSU500B	500	2

CARTONS

Code	Pieces	Pk Qty
LIPSU1000C	1,000	1
LIPSU2000C	2,000	1

Lippage Spacers

- Used in conjunction with lippage caps
- Made from nylon
- Designed to level lippage on tiles when laying
- Ideal for floors and walls
- Curved base to allow for different tile thicknesses
- Suitable for up to 1-3/16" high

DIMENSIONS - 3"(H) x 9/16"(W) x 5/64"(T)
Grout joint size: 3/32"



BAGS

Code	Pieces	Pk Qty
LIPS100	100	10

BUCKETS

Code	Pieces	Pk Qty
LIPS250B	250	6
LIPS500B	500	2
LIPS1000B	1,000	1

Lippage Caps

- Caps secure to lippage spacer
- Designed to level lippage on tiles when laying
- Reusable Caps with metal tongue to increase longevity
- Ideal for floors and walls

DIMENSIONS - 1-5/8"(H) x 7/16"(W) x 5/8"(T)

BAGS

Code	Pieces	Pk Qty
LIPC100	100	10

BUCKETS

Code	Pieces	Pk Qty
LIPC250B	250	6



Wedge Lippage System

- Tile levelling system designed to create a lippage free surface
- Use with wedge lippage spacer

BAGS

Code	Pieces	Pk Qty
WLW100A	100	10

CARTONS

Code	Pieces	Pk Qty
WLW2000A	2000	1



Wedge Lippage Spacers

- Tile levelling system designed to create a lippage free surface
- Nylon Spacers designed for thin panel
- Plastic spacers designed for tiles up to 1/2"

BAGS

Code	Type	Grout joint	Pieces	PK Qty
WLS250A	Nylon	1/16"	250	5
WLS500A	Nylon	1/16"	500	3
WLS250P	Plastic	1/16"	250	24
WLS500P	Plastic	1/16"	500	3
WLS3-250P	Plastic	1/8"	250	24
WLS3-500P	Plastic	1/8"	500	3

CARTONS

Code	Type	Pieces	PK Qty
WLS1000A	Nylon	1000	1
WLS2000A	Nylon	2000	1
WLS4800A	Nylon	4800	1
WLS1000P	Plastic	1000	1
WLS2000P	Plastic	2000	1



Nylon



Plastic

BUCKETS

Code	Type	Grout joint	Pieces	PK Qty
WLS3-1000P	Plastic	1/8"	1000	2
WLS3-2000P	Plastic	1/8"	2000	1

Wedge Levelling Tool

Code: **WLFT**

Pk Qty: **6**

- Adjustable Tension
- Adjustable for different tile thicknesses
- Tile levelling system for quick tile installation and lippage-free surface



Adhesive Mosaic Mesh 12" x 12"

- Designed to adhere to the back of mosaic tiles to increase thickness to ensure they sit level with other tiles
- Supports mosaics & prevents slipping
- Makes mosaic tiling quick & easy

Code	Size	QTY
TMS5A	12" x 12" x 3/64"	6
TMS50A	12" x 12" x 3/64"	1

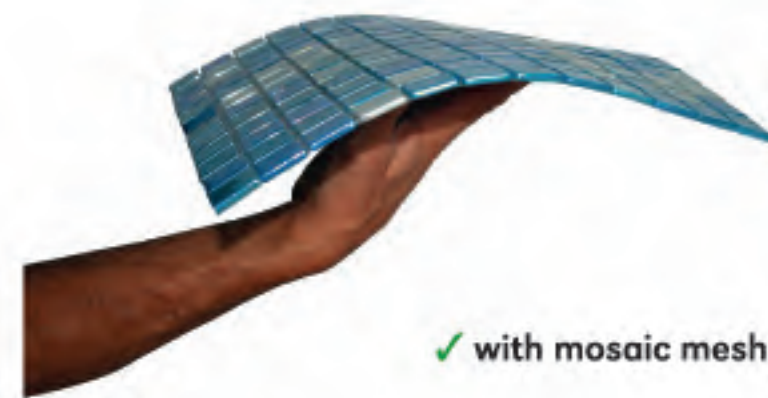
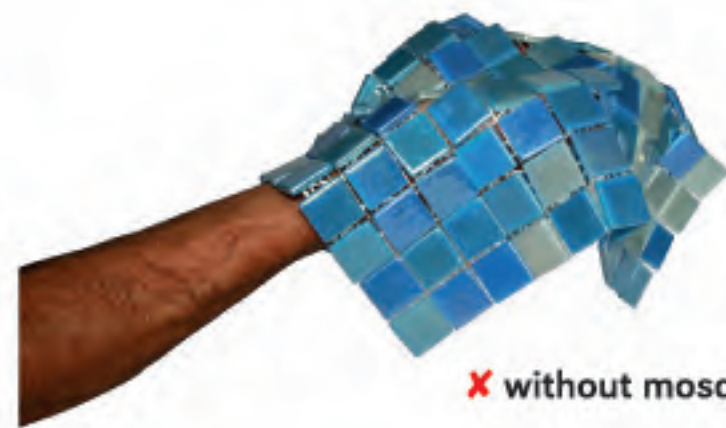
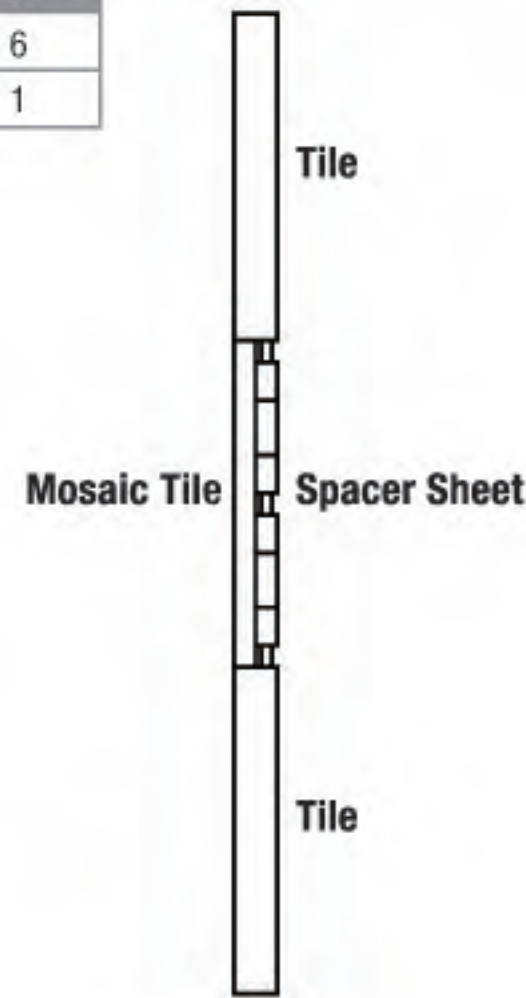
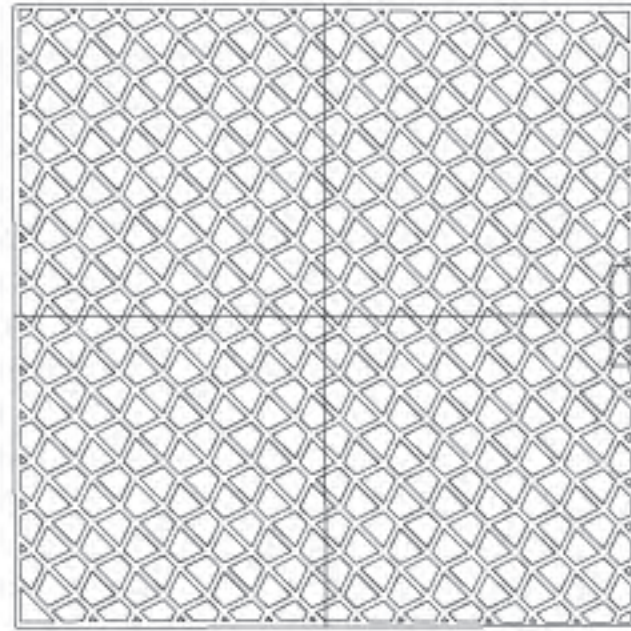

Mosaic Sheet without Adhesive

- Designed to adhere to the back of mosaic tiles to increase thickness to ensure they sit level with other tiles
- Supports mosaics & prevents slipping
- Makes mosaic tiling quick & easy

Code	Size	QTY
TMS10	12" x 6" x 3/32"	10
TMS50	12" x 12" x 3/64"	1

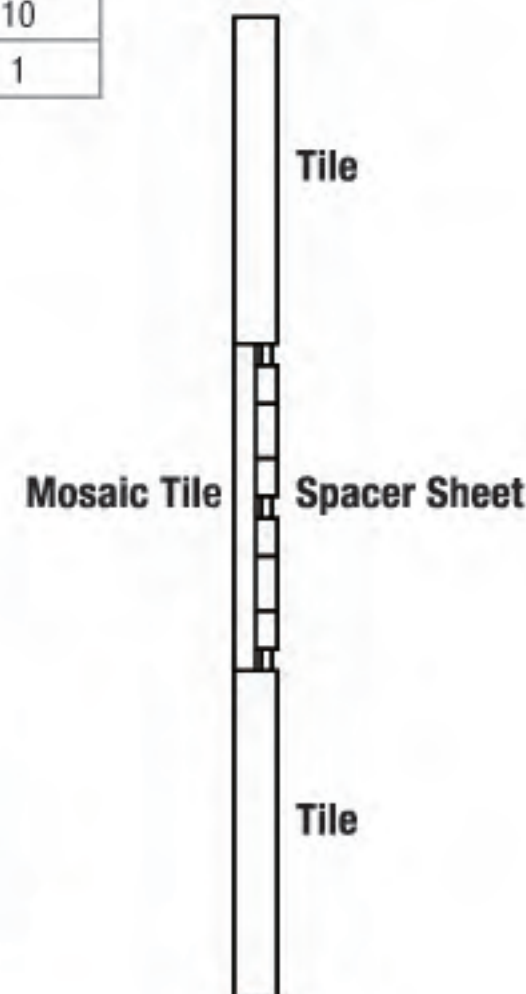
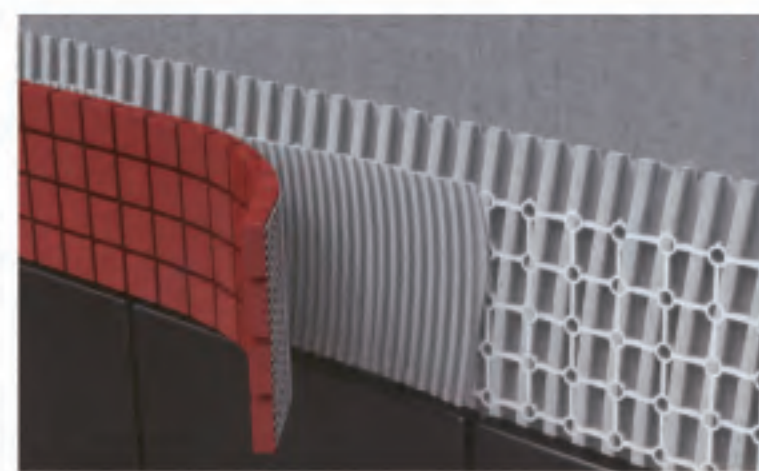
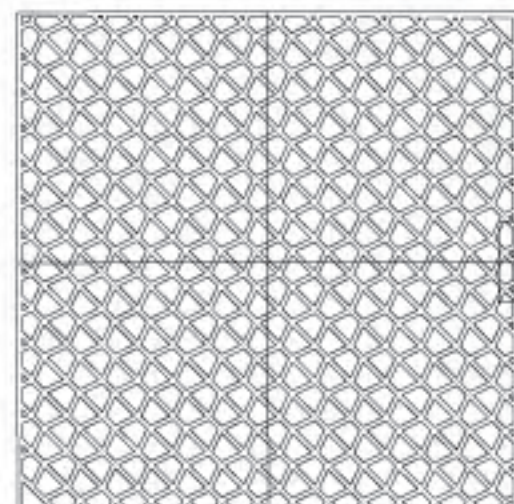
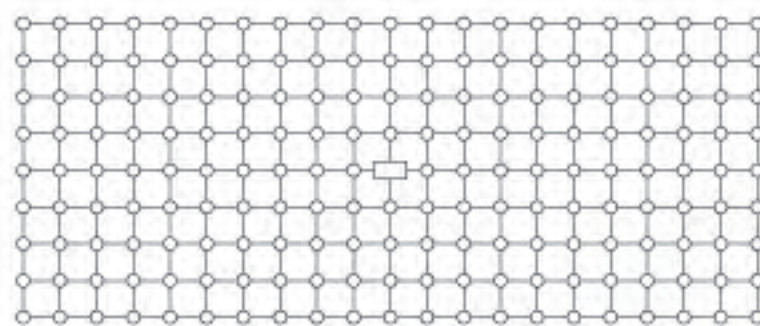

Tile Spacers

- Cross type spacer and T shaped spacer
- For straight / diagonal offset laying of floor / wall tiles

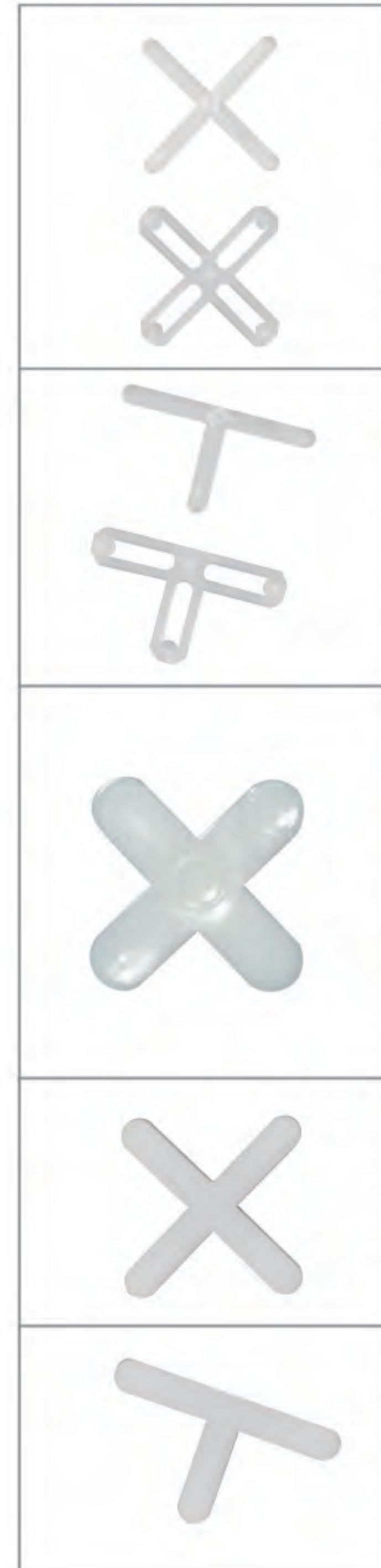

Size	Code	Unit QTY	Case QTY
Hard Plastic Cross Spacers			
1/16	TSL15-500	500 Bag	20
1/16	TSL15-1000B	1000 Bkt	12
1/8	TSL3-500	500 Bag	20
1/8	TSL3-700B	700Bkt	12
3/16	HTS5-500	500 Bag	20
3/16	HTS5-400B	400 Bkt	12
1/4	HTS6-500	500 Bag	20
1/4	HTS6-500B	500 Bkt	12
Hard Plastic T Spacers			
1/16	TST15-500	500 Bag	20
1/16	TST15-1400B	1400 Bkt	12
1/8	TST3-500	500 Bag	20
1/8	TST3-1100B	1100Bkt	12
3/16	HTST5-500	500 Bag	20
3/16	HTST5-800B	800 Bkt	12
1/4	HTST6-500	500 Bag	20
1/4	HTST6-500B	500 Bkt	12
Regular Soft Spacers			
1/16	STS15-300	300 Bag	20
1/16	STS15-2500B	2500 Bkt	12
1/8	STS3-150	150 Bag	20
1/8	STS3-1600B	1600Bkt	12
3/16	STS45-150	150 Bag	20
3/16	STS45-750B	750 Bkt	12
1/4	STS6-100	100 Bag	20
1/4	STS6-500	500 Bkt	12
3/8	STS10-150	150 Bag	20
3/8	STS10-300B	300 Bkt	12
Long Soft Cross Spacers			
1/8	STSL3-150	150 Bag	20
1/8	STSL3-800B	800 Bkt	12
3/16	STSL45-150	150 Bag	20
3/16	STSL45-400B	400Bkt	12
1/4	STSL6-100	100 Bag	20
1/4	STSL6-300B	300 Bkt	12
Long Soft T Spacers			
1/8	STST3-150	150 Bag	20
1/8	STST3-900B	900 Bkt	12
3/16	STST45-150	150 Bag	20
3/16	STST45-500	500 Bkt	12
1/4	STST6-150	150 Bag	20
1/4	STST6-400B	400 Bkt	12



Horseshoe Shims

- Non Compressive
- Professional grade shims

1/16" Horseshoe Shims		
Code	Pieces	Pk Qty
HSS15-200	200 Bkt	12
HSS15-1000	1000 Box	1

1/8" Horseshoe Shims		
Code	Pieces	Pk Qty
HSS3-150	150 Bkt	12
HSS3-1000	1000 Box	1

3/16" Horseshoe Shims		
Code	Pieces	Pk Qty
HSS5-110	110 Bkt	12
HSS5-1000	1000 Box	1

1/4" Horseshoe Shims		
Code	Pieces	Pk Qty
HSS14-100	100 Bkt	12
HSS14-1000	1000 Box	1

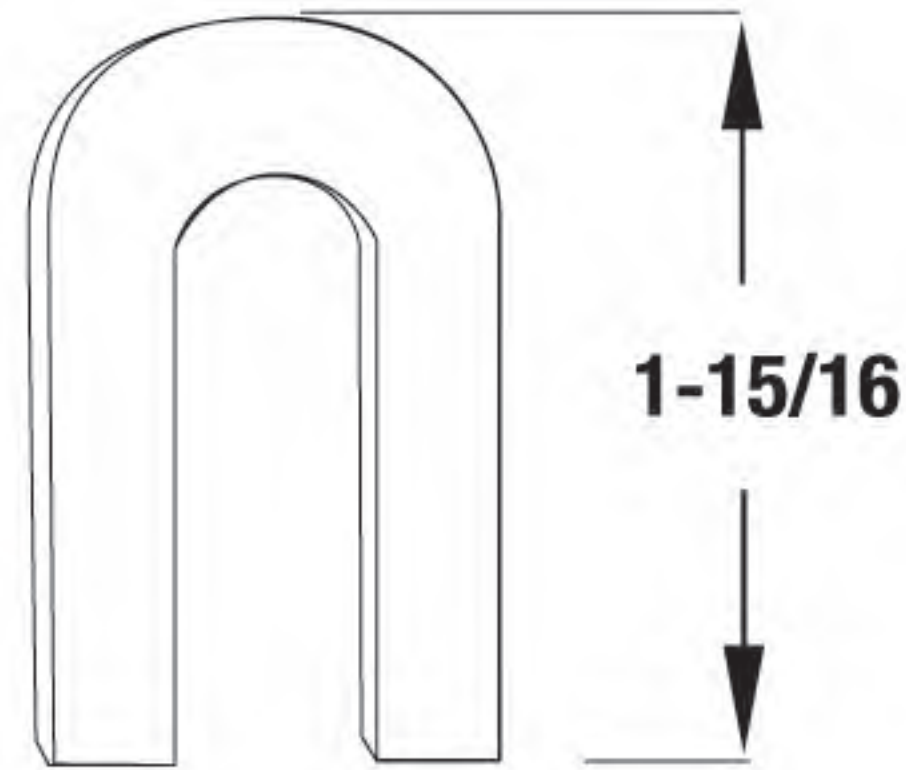

White Wedges

Code: **WW-500H**

Pk Qty: **12**

- Professional Grade Tile Wedge
- 500 Per Jar



5/8"(W) x 1/2"(L) x 1/8"(H)

Jumbo White Wedges

Code: **JWW-75**

Pk Qty: **12**

- Professional Grade Jumbo Tile Wedge
- 75 Per Jar



15/16"(W) x 1-1/8"(L) x 1/4"(H)

Stone Fabricators Wedge

Code: **WJP-50**

Pk Qty: **10**

- Professional Grade Stone Fabricators Wedge
- 50 Per Bag



3-1/4" x 1-1/2" x 1/4"

Wood Floor Wedges

Code: **FW-4**

Pk Qty: **12**

- Insert between the wall and the first row of flooring
- Adjustable to work with uneven walls
- Durable construction
- Adjustable dial setting (5mm-20mm / 3/16"-3/4")
- 60mm / 2-3/8" face width



Red Wedges

- Euro Style Red Wedges

Code	Pieces	Pk Qty
W-100	100 Bag	100
W-500B	500 Bkt	12



Jumbo Wedges

- Euro Style Jumbo Wedges

Code	Pieces	Pk Qty
WJ-250	250 Bag	25
WJ-500	500 Bag	10



Safety and Surface Protection



The B's Knees

- Hard anti-roll outer shell
- Designed for extra stability
- Velcro Straps for easy adjustments
- Superior padding for extra comfort

Precision Ultra

- Hard wearing rubber outer shell with soft molded rubber insert
- Contoured for maximum comfort

Professional Knee Pads

- Premium grade neoprene
- Single velcro front fastening strap
- Washable



The Choice of Professionals

www.dtausagroup.com



Neoprene Knee Pad - Large

Code: **NKP2**
Pk Qty: **12**

- Durable, washable and comfortable, one size fits all knee pad
- Also useful for gardening, plumbing, paving, cleaning and concreting



Deluxe Hard Shell Knee Pad

Code: **KPD**
Pk Qty: **12**

- Hard anti-roll outer shell
- Designed for extra stability
- Velcro straps - for easy adjustments
- Superior padding - for extra comfort



Rubber Knee Pad - Economy

Code: **RKP**
Pk Qty: **20**

- Hard wearing, one size fits all, waterproof knee pad
- Touch tape fastening and accurately knee shaped



Precision Ultra Knee Pads (USA)

Code: **PKN1**
Pk Qty: **6**

- Hard wearing rubber outer with soft foam insert
- Contoured for maximum comfort

REPLACEMENT PARTS -
PKN1S - 4 Straps
PKN1I - 2 Padded Inserts
PKN1SB - 8 Buttons



Tradesman Ultra Knee Pads

Code: **DTAPKN1**
Pk Qty: **12**

- Hard wearing rubber outer with molded rubber insert
- Contoured for maximum comfort

REPLACEMENT PARTS -
DTAPKN1S - 4 Straps
DTAPKN1I - 2 Padded Inserts
DTAPKN1B - 8 Buttons



Knee Board With Rollers

Code: **KBR**
Pk Qty: **6**

- Contoured padding to protect the knees
- Recessed tray for holding tools, spacers, nippers, etc.
- 5 rotating wheels
- Durable plastic construction
- Convenient carry handle



Professional Neoprene Knee Pads

Code: **BPSO-XL**
Pk Qty: **6**

- Single velcro front fastening strap
- Washable
- Top of the line knee pad shape provides extreme comfort and strength
- DTA Neoprene soft knee pad with durable cover



Professional Knee Pads

Code: **BPKP-XL**
Pk Qty: **6**

- Non-marking bicast leather cover
- Premium grade neoprene
- Single velcro front fastening strap
- Comfortable design
- Washable
- Durable



Thick Latex Gloves

Code	Description	Size	Pk Qty
GLOVBLU-M	Thickest latex gloves Medium	Medium	10
GLOVBLU-L	Thickest latex gloves Large	Large	10
GLOVBLU-XL	Thickest latex gloves X-Large	X-Large	10
GLOVBLU-XXL	Thickest latex gloves XX-Large	XX-Large	10

- 50 gloves per box
- Thickness: 14mil
- Powder-free examination grade latex
- 12" length for added protection
- Beaded cuff for easy donning
- Textured for superior grip
- Strong yet soft and flexible



Tradesman Gloves

Code: **BTGL**
Pk Qty: **10**

- All purpose gloves
- Durable & hard wearing
- Padded palm grip for extra comfort
- Adjustable velcro wrist strap



Heavy Duty Orange Lined grouting gloves

Code: **GLOVHD-L**
GLOVHD-XL
Pk Qty: **24**

- Orange latex, 13" length
- Premium flock lined
- Chemical and Water Resistant
- Available in Large and XLarge



Carpet Protection Film

Code	Size	Pk Qty
FPC70025	28" x 82'	16
FPC80061	24" x 200'	9

- No more drop sheets required, this self adhesive film protects your carpet
- Easily applied and removed
- Protects carpet against dirt and stains



Hard Surface Protection Film

Code: **FPT70025**
Pk Qty: **16**

- No more drop sheets required this self adhesive film protects your hard surface areas
- Easily applied and removed
- Protects laminate, vinyl and tiles as well as stone bench tops
- 28" x 82'



28" Floor Protector Roller Applicator

Code: **FPA700**
Pk Qty: **10**

- Stainless steel barrel
- Push action
- For easy application of film
- For use with carpet and hard-floor protection film



Hardwood and Laminate Repair Kit

Code: **FLRK**
Pk Qty: **12**

- Ideal for repairing scratches and marks on hardwood and laminate floors
- Battery operated melting device (Batteries included)
- 11 wax color sticks
- Blend wax color sticks to create more colors



Temporary Wall System Kit

Code: DSKD

Pk Qty: 1

Kit includes:

- 4 x Aluminum extension poles extends to 12.8'
- 4 x Base plates 4 x Top plates
- 1 x Clear film 13.1' x 16.4' x 60um
- 2 x Adhesive zips 7'
- 12 x Pole U-Clips
- 1 x 55" Aluminum support bar
- 1 x Carry bag
- Ideal for Trade or DIY
- Partitions areas off to protect against dust and debris
- Multiple applications
- Versatile access point
- Easy to install
- Reusable
- Black film can be used for privacy



1. Attach the plastic sheet to the pole with the end clips. 2. Attach the support clamp to the spring loaded head. 3. Raise the pole with spring loaded head against the ceiling. Start at either side.



4. Adjust the pole length and lock into position with clock-wise twist. 5. Secure the sheet vertically with the U-clips. 6. To create an access: apply the adhesive zipper, open and cut the sheet following the zipper.

Felt Protective Roll

Code: DSFR

Pk Qty: 12

- 39" x 10.9Y
- Anti-Absorbent Backing
- Ideal Applications:
- Tiling
- Painting
- Renovations



Dirt Free Sticky Mat

Code: SM2436

Pk Qty: 12

- Ideal for contractors and renovators who need to keep the site clean
- 30 sticky mats
- Size – 24" x 36"
- Once the mat is no longer effectively cleaning the sole of the shoe peel 1 layer off to expose a clean sheet



Plastic Zip Door

Code: DPZ

Pk Qty: 10

- Helps prevent mess spreading whilst renovating
- Heavy duty clear plastic material
- Allows access into work areas that have been sealed off to contain dust & debris
- Suitable for doorways up to 1 metre wide
- Commercial grade polyester zipper



Adhesive Access Zipper 215cm / 7' Long

Code: DSZIP-2

Pk Qty: 6

- Adhere adhesive zipper at desired access point
- Open zipper and slice plastic to allow access
- 2pcs per pack





PROFESSIONAL DIAMOND BLADES

PROFESSIONAL DIAMOND BLADES



BOSS PROFESSIONAL DIAMOND BLADES

DTA distribute a vast range of professional quality diamond cutting blades that can cut everything from quarry tiles to concrete. Choosing the correct blade for the material is essential, so check our chart to help your selection. DTA diamond blades render trouble free service, cut after cut.

Supreme Tile Saw Blades

- The Boss Supreme blade's diamond formulation provides cleaner, faster, smoother and chip free cutting of various tile and vitreous materials.



Item #	Specs	Rim Height	Pk Qty
DBST060	6" x .060 x 5/8	10mm	1
DBST070	7" x .060 x 5/8	10mm	1
DBST080	8" x .060 x 5/8	10mm	1
DBST100	10" x .060 x 5/8	10mm	1

Application	Wet Continuous
Ceramic Tiles	✓
Critically Hard Tiles	✓
Porcelain	✓
Slate	✓
Marble	✓
Granite	✓
Terracotta	✓

Premium Tile Saw Blades

- The Boss Premium blades have a continuous rim that offers a great value for smooth and fast cutting of ceramic, porcelain and natural stone tiles.



Item #	Specs	Rim Height	Pk Qty
DBPT070	7" x .060 x 5/8	10mm	1
DBPT100	10" x .060 x 5/8	10mm	1

Application	Wet Continuous
Ceramic Tiles	✓
Critically Hard Tiles	✓
Porcelain	✓
Slate	✓
Marble	✓
Granite	✓
Engineered Stone	X

Laser Cut Diamond Blade

- The Boss Laser cut blade has a supreme diamond bond and features laser-cut slots which help release stress, eliminate wobbling and reduce vibration for a cleaner, faster cut.

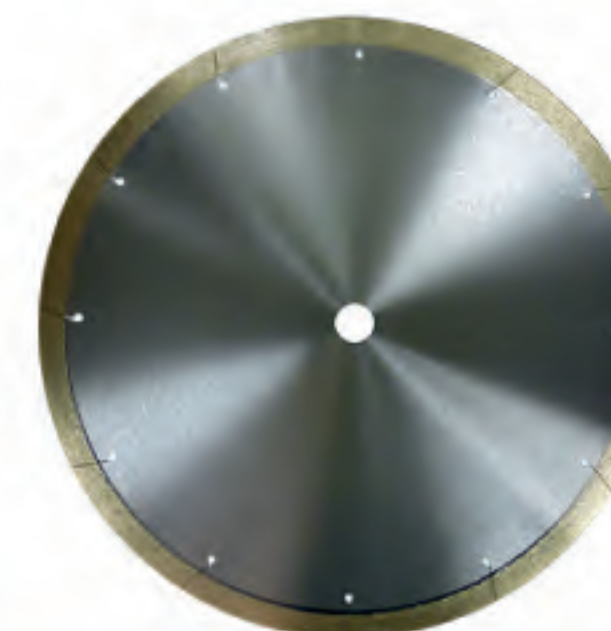

Item #	Specs	Rim Height	Pk Qty
DBLC070	7" x .060 x 5/8	8mm	1
DBLC100	10" x .060 x 5/8	10mm	1

Application	Wet Continuous
Ceramic Tiles	✓
Critically Hard Tiles	✓
Porcelain	✓
Slate	✓
Marble	✓
Granite	✓
Engineered Stone	X



Supreme Glass Tile Saw Blades

- The Boss Supreme Glass Blade has a specially formulated continuous rim with super fine diamonds for smooth and chip-free cutting of glass.

Item #	Specs	Rim Height	Pk Qty
DBSG040	4" x .060 x 5/8	10mm	1
DBSG070	7" x .060 x 5/8	10mm	1
DBSG100	10" x .060 x 5/8	10mm	1



Application	Wet Continuous
Glass	✓

Zenesis Blades

- Unique slot and rim design give the ZENESIS Continuous Rim Blade unparalleled cutting precision and performance, all without breaking a sweat. Since the blade incorporates ZENESIS pattern technology, fabricators can count exceptionally smooth, chip-free cutting of porcelain tile, granite and other hard materials.

Item #	Blade Diameter	Pk Qty
DBZEN040	4"	1
DBZEN045	4.5"	1
DBZEN050	5"	1
DBZEN060	6"	1
DBZEN070	7"	1
DBZEN080	8"	1
DBZEN080-DM	8"	1
DBZEN100	10"	1
DBZEN120	12"	1
DBZEN120-60	12"	1
DBZEN140	14"	1
DBZEN140-60	14"	1

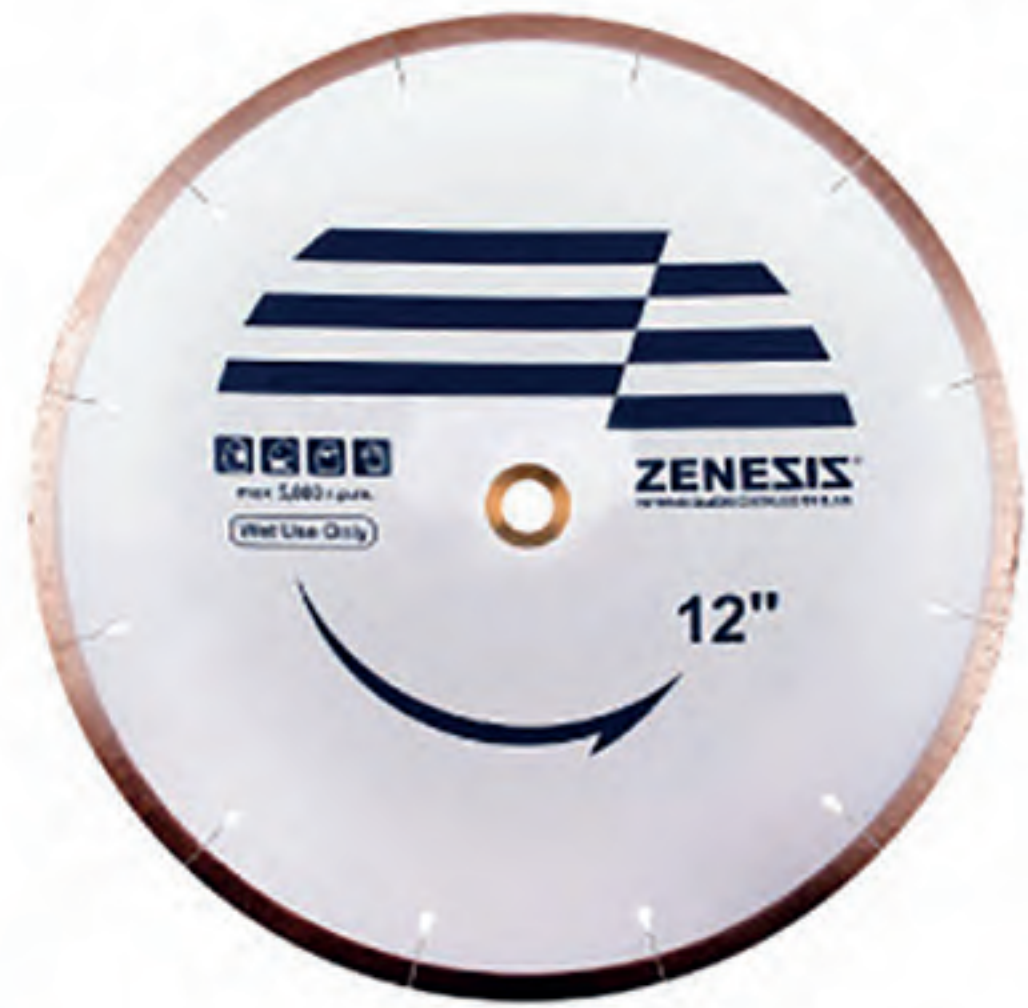

Premium Dry Cutting Grinder Blades

- The Boss Premium Dry Grinder Blade is designed for dry cutting of ceramic, porcelain and natural stone. The continuous rim gives a smooth and clean cut.

Item #	Specs	Rim Height	Pk Qty
DBD040	4" x .060 x 5/8	7mm	1
DBD045	4.5" x .060 x 5/8	7mm	1



Application	Dry Continuous
Ceramic Tiles	✓
Critically Hard Tiles	✓
Porcelain	✓
Slate	✓
Marble	✓
Granite	✓

Dry Continuous Diamond Blade

- Dry & wet cutting
- Clean chip-free cut
- Ideal for ceramic, porcelain and natural stone

Code	Blade Diameter	Rim Height	Pk Qty
TCC105A	4"	7mm	10
TCC115A	4.5"	7mm	10
TCC125A	5"	7mm	10



Application	Dry Continuous
Ceramic Tiles	✓
Critically Hard Tiles	✓
Porcelain	✓
Slate	✓
Marble	✓
Granite	✓
Terracotta	✓
Fibreglass	✓
Fibro Cement	✓

Supreme Turbo Blades

- The Boss Supreme Turbo Blades have a supreme diamond formulation for fast, smooth and clean cut. The blade comes with holes for a flush mount adapter.

Item #	Specs	Rim Height	Pk Qty
DBST040	4" x .070 x 7/8-5/8, pearl gold	7mm	1
DBST045	4.5" x .070 x 7/8-5/8, pearl gold	7mm	1
DBST050	5" x .070 x 7/8-5/8, pearl gold	7mm	1



Application	Super Turbo
Ceramic Tiles	✓
Critically Hard Tiles	✓
Porcelain	✓
Slate	✓
Marble	✓
Granite	✓
Terracotta	✓
Concrete	✓



DTA White Lightning Series

- Extremely thin blade for fast cutting
- Cuts cleanly and precisely
- Wet or dry use
- Extra Core Strength

This blade requires air as a dry coolant or water as a wet coolant



Code	Blade Diameter	Rim Height	Pk Qty
TT105A	4"	9mm	10
TT115A	4.5"	9mm	10
TT125A	5"	9mm	10
TT250A	10"	9mm	10

Application	Super Thin Turbo
Ceramic Tiles	✓
Critically Hard Tiles	✓
Porcelain	✓
Slate	✓
Marble	✓
Granite	✓
Terracotta	✓
Glass	✓
Fibreglass	✓
PVC Pipes	✓
Concrete	✓
Reinforced Concrete	X
Fibro Cement	✓
Clay Bricks	✓
Clay Pavers	✓
Bluestone	✓

Phantom Series Diamond Blade

- Diamond mesh blade designed for precision cutting of porcelain tiles with reduced chipping of tiles

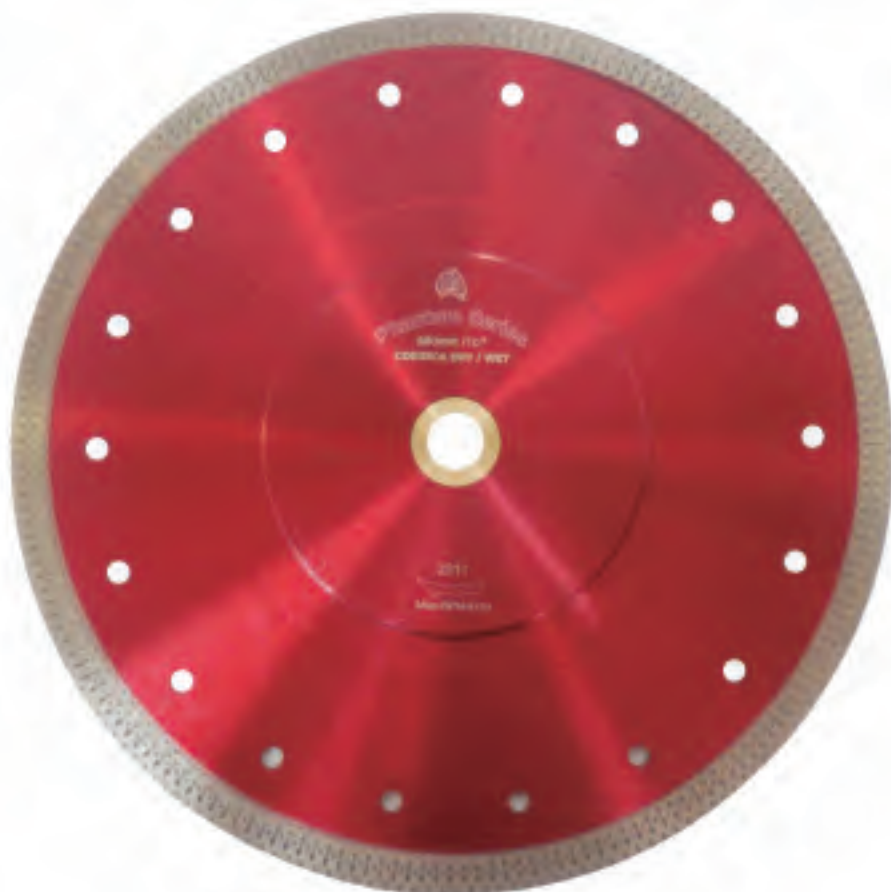

Code	Blade Diameter	Rim Height	Pk Qty
CDB105A	4"	10mm	10
CDB115A	4-12"	10mm	10
CDB125A	5"	10mm	10
CDB180A	7"	10mm	5
CDB250A	10"	10mm	5

Application	Mesh
Ceramic Tiles	✓
Critically Hard Tiles	✓
Porcelain	✓
Slate	✓
Marble	✓
Granite	✓
Terracotta	✓
Glass	✓
Fibreglass	✓
PVC Pipes	✓
Concrete	✓
Reinforced Concrete	X
Fibro Cement	✓
Clay Bricks	✓
Clay Pavers	✓
Bluestone	✓

Supreme Thin Turbo Blade

- Precast flange
- Great for hard material like porcelain, granite, ceramic etc



Code	Blade Diameter	Rim Height	Pk Qty
DBKT040	4"	7mm	10
DBKT045	4-12"	7mm	10
DBKT050	5"	7mm	10

Green Wave Core Blades

- The wave core design of the blade provides a strong core that allows air to circulate, displace debris and enhance cutting speed.



Item #	Specs	Rim Height	Pk Qty
DBGW040	4" x .095 x 7/8-5/8, pearl green	8mm	1
DBGW045	4.5" x .10 x 7/8-5/8, pearl green	8mm	1
DBGW050	5" x .10 x 7/8-5/8, pearl green	8mm	1

Application	Turbo
Ceramic Tiles	✓
Critically Hard Tiles	✓
Porcelain	✓
Slate	✓
Marble	✓
Granite	✓
Terracotta	✓
Concrete	✓
Reinforced Concrete	X
Fibro Cement	✓
Clay Bricks	✓
Clay Pavers	✓
Bluestone	✓

Turbo Diamond blade

- Superior value
- Fast cutting
- Use dry or wet



Code	Blade Diameter	Rim Height	Pk Qty
TCT105A	4"	8mm	10
TCT115A	4.5"	8mm	10
TCT125A	5"	8mm	10

Application	Turbo
Ceramic Tiles	✓
Slate	✓
Marble	✓
Granite	✓
Terracotta	✓
Fibreglass	✓
PVC Pipes	✓
Concrete	✓
Fibro Cement	✓
Clay Bricks	✓
Bluestone	✓



Diamond Coated Drill Bits

- Long lasting electroplated diamond coating
- Drill bits are designed for Porcelain, Ceramic and Natural stone
- Work with standard variable speed drills

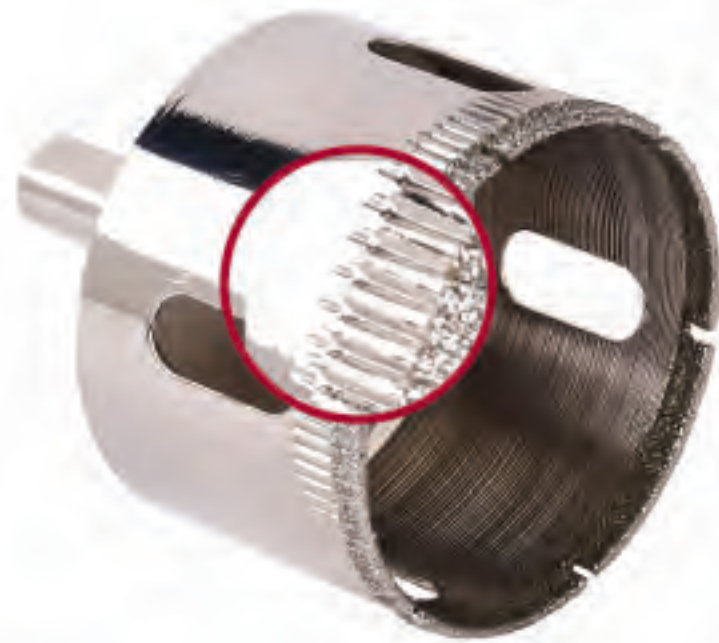

Code	Size	PK Qty
DCT04E	Diamond Drill Bits 5/32"	12
DCT06E	Diamond Drill Bits 1/4"	12
DCT08E	Diamond Drill Bits 5/16"	12
DCT10E	Diamond Drill Bits 3/8"	12
DCT12E	Diamond Drill Bits 1/2"	12
DCT16E	Diamond Drill Bits 5/8"	10
DCT20E	Diamond Drill Bits 3/4"	10
DCT22E	Diamond Drill Bits 7/8"	10
DCT25E	Diamond Drill Bits 1"	10
DCT28E	Diamond Drill Bits 1-1/8"	10
DCT32E	Diamond Drill Bits 1-1/4"	6
DCT35E	Diamond Drill Bits 1-3/8"	6
DCT38E	Diamond Drill Bits 1-1/2"	6
DCT45E	Diamond Drill Bits 1-3/4"	10
DCT50E	Diamond Drill Bits 2"	6
DCT55E	Diamond Drill Bits 2-3/16"	6
DCT60E	Diamond Drill Bits 2-3/8"	6
DCT64E	Diamond Drill Bits 2-1/2"	6
DCT70E	Diamond Drill Bits 2-3/4"	10
DCT75E	Diamond Drill Bits 3"	10
DCT88E	Diamond Drill Bits 3-1/2"	10
DCT110E	Diamond Drill Bits 4-1/4"	10
DCT115E	Diamond Drill Bits 4-1/2"	10

Diamond Core Bits Wet

- High quality long lasting core bits
- 5/8" - 11 arbor fits standard polishers and grinders
- Core bits are designed for Porcelain, Ceramic and Natural stone

Code	Size	PK Qty
3448	Diamond Core Bit 1/2"	10
3441	Diamond Core Bit 3/4"	10
3320	Diamond Core Bit 1-1/4"	10
4007	Diamond Core Bit 1-3/8"	10
3322	Diamond Core Bit 1-1/2"	10



Turbo Diamond Hole Saw

- High quality long lasting core bits
- 3/8" Shank fits standard drills
- Core bits are designed for Porcelain, Ceramic and Natural stone

Code	Size	PK Qty
CBW34	Core Bit Wet 3/4"	10
CBW1	Core Bit Wet 1"	10
CBW114	Core Bit Wet 1-1/4"	10
CBW138	Core Bit Wet 1-3/8"	10
CBW112	Core Bit Wet 1-1/2"	10
CBW2	Core Bit Wet 2"	10



Diamond Core Bits Dry

- High quality long lasting core bits
- 5/8" - 11 arbor fits standard polishers and grinders
- Core bits are designed for Porcelain, Ceramic and Natural stone

Code	Size	PK Qty
CBD1	Core Bit Dry 1"	10
CBD114	Core Bit Dry 1-1/4"	10
CBD138	Core Bit Dry 1-3/8"	10
CBD112	Core Bit Dry 1-1/2"	10
CBD2	Core Bit Dry 2"	5



Tornado Dry Cut Diamond Drill Bit

- Hexagonal shaft
- 2000-3000 RPM
- Suitable for the dry drilling of porcelain, marble, granite, ceramic, limestone, slate, terracotta, fiberglass, glass, travertine and masonry



Size	Code	Pk Qty
3/16"	DDB05	12
1/4"	DDB06	12
5/16"	DDB08	12
3/8"	DDB10	12
1/2"	DDB12	12
3/4"	DDB20	10
1"	DDB25	10
1-3/8"	DDB35	10



Tornado Dry Cut Drill Bits

- 5/8" - 11 arbor
- 6000 - 11000RPM
- Suitable for the dry drilling of porcelain, marble, granite, ceramic, limestone, slate, terracotta, fiberglass, travertine and masonry



Size	Code	Pk Qty
1/4"	TBDD06A	12
5/16"	TBDD08A	12
3/8"	TBDD10A	12
1/2"	TBDD12A	12
3/4"	TBDD19A	10
1"	TBDD25A	10
1-1/4"	TBDD32A	10
1-3/8"	TBDD35A	10
1-1/2"	TBDD38A	10
2"	TBDD50A	5
2-3/16"	TBDD55A	5
2-1/2"	TBDD65A	5
3-1/2"	TBDD88A	5
4-3/8"	TBDD110A	5

11 Piece Diamond Hole Saw Kit

Code: 66810511

Pk Qty: 1



- Heavy duty electroplated diamond bits
- Set includes 1/4, 5/16, 3/8, 3/4, 1-1/4, 1-1/2, 1-3/4, 2, 2-1/2, 2-5/8" bits, universal drill guide and aluminum case



14 Piece Diamond Hole Saw Kit

Code: 66171414

Pk Qty: 1



- Heavy duty electroplated diamond bits
- Set includes 5/32, 1/4, 5/16, 3/8, 1/2, 5/8, 7/8, 1, 1-1/4, 1-3/8, 1-9/16" bits, 4" steel universal drill guide and 1.1L cooling system



3 Piece Diamond Hole Saw Kit

Code: 66810103

Pk Qty: 1



- Heavy duty electroplated diamond bits
- Set includes three 1-3/8" bits and aluminum case





5 Piece Diamond Hole Saw Kit

Code: 1955

Pk Qty: 1



- Heavy duty electroplated diamond bits
- Set includes 5/32", 1/4", 5/16", 3/8", 1/2" diamond hole saws



Adjustable Hole Cutter

Code: 09-295

Pk Qty: 24

1-1/8" - 3-1/2" ADJUSTABLE CUTTER

- Tungsten carbide tips
- Ideal for ceramic wall tiles
- Attaches to a hand or slow speed drill



Tile Glass Drill Bit

- Drill 1/8", 5/32", 3/16", 1/4", 5/16", 3/8" and 1/2" holes
- Suited to ceramic wall tiles or glass
- Recommended drilling speed 1000RPM

Size	Code	Pk Qty
1/8"	0801	10
5/32"	0803	10
3/16"	0805	10
1/4"	0806	10
5/16"	0808	10
3/8"	0810	10

Mini PVC Suction Cup and Guide

Code: DTAMSCG

Pk Qty: 6

- Suitable for 5/32", 1/4", 5/16", 3/8" and 1/2" drill bits
- Pressurised water bottle can be attached to add water(DTAWB)



Suction Ring Set

Code: SRS

Pk Qty: 6

- Helps keep drilling area clean
- Easier to use than plumbers putty prolongs life of your drill bits
- 3" & 1-1/2"



PVC Suction Cup and Guide

Code: DTASCG

Pk Qty: 6

- Guide suited for drilling 1/4" - 3-1/4" holes
- Suction cup ensures stability while using guide for vertical or horizontal drilling
- Ideal for carrying marble, granite or glass tiles and for removing broken or misplaced tiles



PVC Suction Cup and Guide with Water Supply

Code: DTASCGW

Pk Qty: 12

- Ideal for use when cutting holes with diamond drill bits
- Can be used vertically
- Easy to use and portable
- Guide suited for 1/4" - 3-1/4" holes



Pressurised Water

Code: DTAWB

Pk Qty: 20

- Can be used with DTAMSCG, DTAUSCG, DTASCG
- Can also be used to apply grout cleaner



DTA Diamond Blade Sharpening Stones

Code: DBDS

Pk Qty: 24

- Designs to re-expose blade diamonds if they foul or clog up during clay cutting



Resin Dressing Stone

Code: DBDS-FX

Pk Qty: 36

- 6"(L) x 1-3/4"(W) x 1"(D)



CYCLONE SERIES



CYCLONE SERIES

The DTA Cyclone Series has been designed to cover a range of products from cutting, grinding and dust extraction.



5" Diamond Cup Grinding Dust Extractor

Code: DEC125

Pk Qty: 6



- Suits 4" - 5" grinding cups
- Movable guard for grinding up to walls
- Brush base provides support for a cushion action
- Includes universal adapter to suit most vacuums
- Attachment sleeves suit most grinders



7" Dust Extraction Shroud

Code: DEC180

Pk Qty: 6



- Ideal for use with grinding discs
- 1-3/8" vacuum outlet
- Removable guard for grinding against walls
- Brush base provides support for a cushion action
- Attachment sleeves suit most grinders



Diamond Blade Dust Extractor

Code: DEXBC

Pk Qty: 6



- Removes dust while cutting
- Suits 4" - 5" blades
- Includes universal adapter to suit most vacuums



Dust Extractor Suction Drill Guide

Code: DEXSG

Pk Qty: 6



- Dust-free-drilling
- Connects to a vacuum cleaner with a hose outlet of 1-1/4" - 1-1/2"
- Suitable for tile, plaster, stone and non porous materials
- Can be used with drills to a maximum diameter of 2-1/2"
- Made from Durable Plastic material



Bucket Dust Extractor

Code: DEXBA

Pk Qty: 1

- Dust-free mixing
- Includes rubber adaptor
- Used in conjunction with industrial vacuums
- Suitable for most buckets
- Ideal when mixing powder affrsives, grouts and plaster



DTA GRINDING AND ABRASIVE WHEELS



DTA GRINDING AND ABRASIVE WHEELS

DTA Grinding Cup Wheels have been developed to assist in the preparation of surfaces, before tiling commences. With a range of different qualities and applications there is a wheel to suit any application.

The PVA Abrasive Wheels are designed to smooth those rough edges, giving a professional finish to any tiled area.

Diamond Cup Grinding Wheels

Diamond Cup Grinding Wheel are designed for dry grinding, levelling and shaping of concrete. Ideal for surface preparation. Suitable for grinding machines and angle grinders.

Single Row

- Coarse and aggressive grinding
- Usage: 80 -120hours

Size	Code	Pk Qty
4"	DGD100SCA	5



Double Row

- General purpose grinding
- Usage: 80 -120hours
- 5/8"-11 arbor

Size	Code	Pk Qty
4"	DGD100DCA	5



Turbo Row

- Finishing, shaping and smoothing
- Usage: 80 -120hours
- 5/8"-11 arbor

Size	Code	Pk Qty
4"	DGD100TCA	5
5"	DGD125TCA	5
7"	DGD175TCA	5



Silicone Carbide Sandpaper Disc

- Wet and dry silicon carbide abrasive discs
- For use with marble, travertine, terrazzo, onyx, glass, metal and wood
- High quality materials will give you the best results

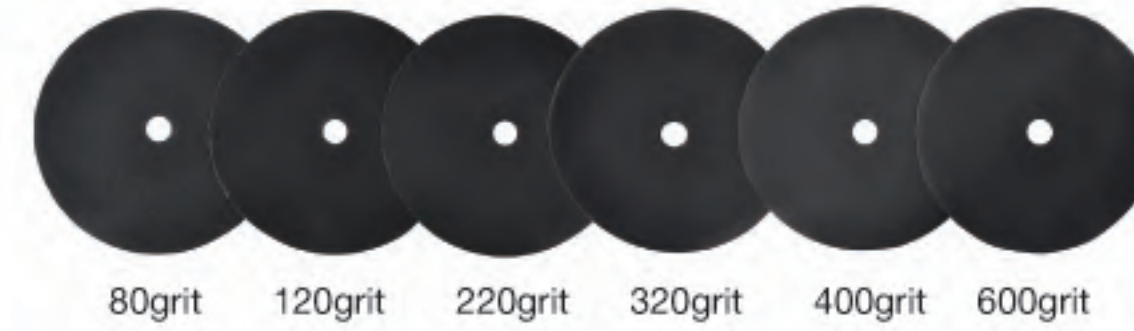

Size	Code	Designed For	Grit	Pk Qty
4"	SCP4-80	Silicone Carbide Sandpaper Disc	80	1
4"	SCP4-120	Silicone Carbide Sandpaper Disc	120	1
4"	SCP4-220	Silicone Carbide Sandpaper Disc	220	1
4"	SCP4-320	Silicone Carbide Sandpaper Disc	320	1
4"	SCP4-400	Silicone Carbide Sandpaper Disc	400	1
4"	SCP4-600	Silicone Carbide Sandpaper Disc	600	1
4"	SCP4-KIT	Silicone Carbide Sandpaper Disc	KIT	1
5"	SCP5-80	Silicone Carbide Sandpaper Disc	80	1
5"	SCP5-120	Silicone Carbide Sandpaper Disc	120	1
5"	SCP5-220	Silicone Carbide Sandpaper Disc	220	1
5"	SCP5-320	Silicone Carbide Sandpaper Disc	320	1
5"	SCP5-400	Silicone Carbide Sandpaper Disc	400	1
5"	SCP5-600	Silicone Carbide Sandpaper Disc	600	1
5"	SCP5-KIT	Silicone Carbide Sandpaper Disc	KIT	1

Diamond Hand Sand Pad

- Electroplated diamond
- Ideal for smoothing rough edges of porcelain



Code	Grit	Pk Qty
DSP60	60	10
DSP120	120	10
DSP200	200	10
DSP400	400	10
DSP600	600	10
DSP800	800	10
DSP-3S	60, 200, 400	10
DSP-4S	60, 200, 400, 600	10

Shaping Stone

- Silicon carbide shaping stone are great for concrete, masonry, granite and marble
- Long lasting premium design



Size	Code	Designed For	Grit	Pk Qty
1.5" x 3"	SS15024	Shaping Stone	24	1
1.5" x 3"	SS15036	Shaping Stone	36	1
1.5" x 3"	SS15046	Shaping Stone	48	1
1.5" x 3"	SS15080	Shaping Stone	80	1
1.5" x 3"	SS15120	Shaping Stone	120	1
1.5" x 3"	SS15220	Shaping Stone	220	1
4" x 2"	SS4024	Shaping Stone	24	1
4" x 2"	SS4036	Shaping Stone	36	1
4" x 2"	SS4046	Shaping Stone	46	1
4" x 2"	SS4060	Shaping Stone	60	1
4" x 2"	SS4080	Shaping Stone	80	1
4" x 2"	SS4120	Shaping Stone	120	1
4" x 2"	SS4220	Shaping Stone	220	1
5" x 2"	SS5024	Shaping Stone	24	1
5" x 2"	SS5036	Shaping Stone	36	1
5" x 2"	SS5046	Shaping Stone	48	1
5" x 2"	SS5060	Shaping Stone	60	1
5" x 2"	SS5080	Shaping Stone	80	1
5" x 2"	SS5120	Shaping Stone	120	1
5" x 2"	SS5220	Shaping Stone	220	1



Vacuum Brazed Profile Wheels

All Vacuum Brazed Profile can be used on all kinds of material, 5/8" threaded for handheld grinders

Ogee Profile		
Code	Size	PK Qty
PWOG34	3/4"	1
PWOG1	1"	1



Dupont Profile		
Code	Size	PK Qty
PWD34	3/4"	1
PWD1-58	1-5/8"	1



Beveled Profile		
Code	Size	PK Qty
PWB316	3/16"	1
PWB14	1/4"	1
PWB38	3/8"	1
PWB58	5/8"	1
PWB34	3/4"	1



Full Bull Nose		
Code	Size	PK Qty
PWFB34	3/4"	1
PWFB1-316	1-3/16"	1
PWFB1-58	1-5/8"	1



Demi-Bull Nose		
Code	Size	PK Qty
PWDB316	3/16"	1
PWDB14	1/4"	1
PWDB38	3/8"	1
PWDB12	1/2"	1
PWDB34	3/4"	1
PWDB1	1"	1



Fiberglass Rod

Item #	Specs	Rim Height	Pk Qty
FG10-328	1/8" x 3/8" x 328FT	3/8"	1
FG6-328	1/8" x 1/4" x 328FT	3/8"	1

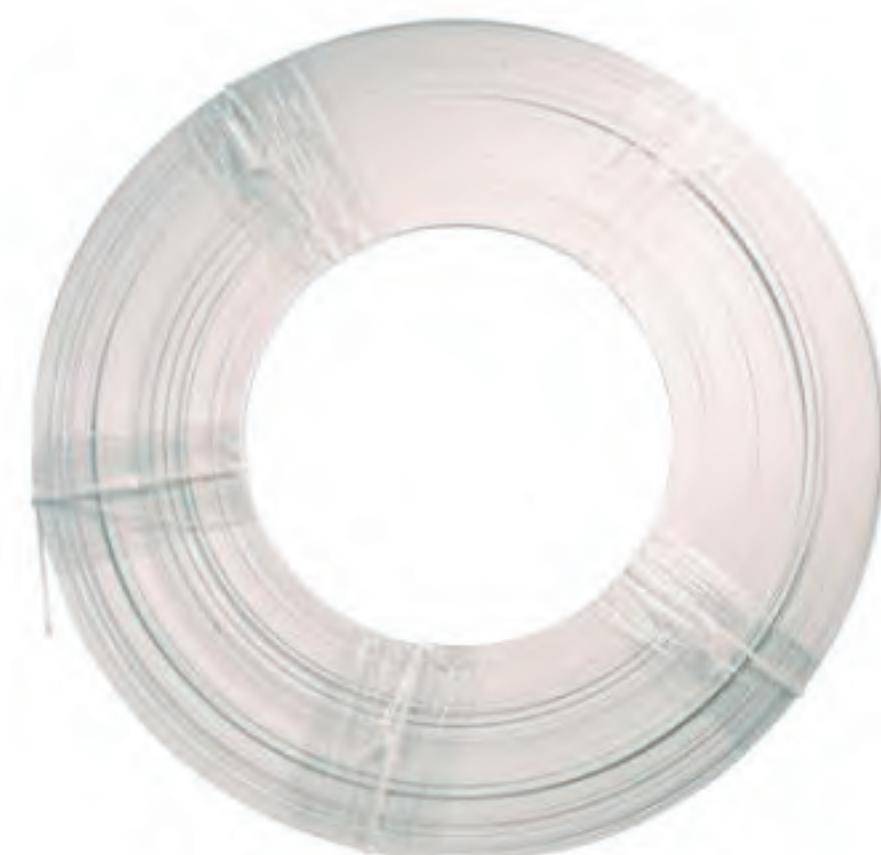

C-CLAMP

Code: C-CLAMP4

PK Qty: 10

- 4" X 3"



PVA Abrasive Wheels

- PVA Abrasive Wheels are designed to polish Marble and Travertine. They also work great on Porcelain and concrete edges 5/8" Bore
- 11,400 RPM Maximum
- Silicon carbide abrasive material 5/8" bore



Size	Code	Grit	PK Qty
4"	PVA100036	36	10
4"	PVA100060	60	10
4"	PVA100120	120	10
4"	PVA100220	220	10
4"	PVA100320	320	10
4"	PVA100400	400	10
4"	PVA100600	600	10
4"	PVA100036-10	36	10
4"	PVA100060-10	60	10
4"	PVA100120-10	120	10
4"	PVA100220-10	220	10
4"	PVA100320-10	320	10
4"	PVA100400-10	400	10
4"	PVA100600-10	600	10
4"	PVA-KIT	60, 120, 220, 400, 600 x 2pcs	10



Flexible Backer Pads

- These durable backer pads are the best on the market, and the preferred pad by contractors
- The flexibility allows the user to get into tight corners with ease
- Works great on tough contours and inside curves

Code	Size	PK Qty
29006035/4	4"	10
29006035/5	5"	10





Wet Diamond Polishing Pads

- Velcro backed polishing discs for polishing granite & marble
- Great for polishing flat surfaces and beveled edges
- Featuring much more flexibility than normal dry pads making them ideal for concave & convex surfaces

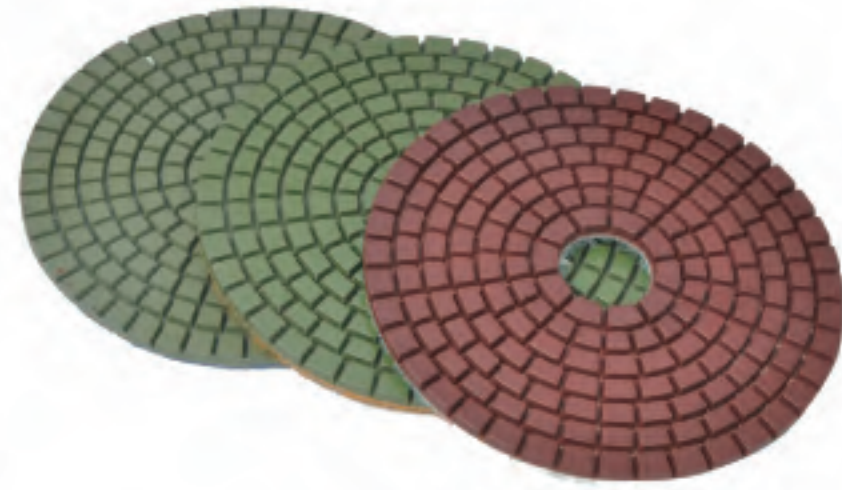

Size	Code	Designed For	Grit	PK Qty
4"	PPW4-0050E	Wet	50	10
4"	PPW4-0100E	Wet	100	10
4"	PPW4-0200E	Wet	200	10
4"	PPW4-0400E	Wet	400	10
4"	PPW4-0800E	Wet	800	10
4"	PPW4-1500E	Wet	1500	10
4"	PPW4-3000E	Wet	3000	10
4"	PPW4-BE	Wet	BUFF	10
4"	PPW4-WE	Wet	BUFF	10
5"	PPW5-0050E	Wet	50	10
5"	PPW5-0100E	Wet	100	10
5"	PPW5-0200E	Wet	200	10
5"	PPW5-0400E	Wet	400	10
5"	PPW5-0800E	Wet	800	10
5"	PPW5-1500E	Wet	1500	10
5"	PPW5-BE	Wet	BUFF	10
5"	PPW5-WE	Wet	BUFF	10

Premium Wet Diamond Polishing Pads

- Velcro backed polishing discs for polishing granite & marble
- Great for polishing flat surfaces and beveled edges
- Featuring much more flexibility than normal dry pads making them ideal for concave & convex surfaces



Size	Code	Designed For	Grit	PK Qty
4"	PPW4-0050	Wet	50	10
4"	PPW4-0100	Wet	100	10
4"	PPW4-0200	Wet	200	10
4"	PPW4-0400	Wet	400	10
4"	PPW4-0800	Wet	800	10
4"	PPW4-1500	Wet	1500	10
4"	PPW4-3000	Wet	3000	10
4"	PPW4-B	Wet	BUFF	10
4"	PPW4-W	Wet	BUFF	10

Premium Dry Diamond Polishing Pads

- Velcro backed polishing discs for polishing granite & marble
- Great for polishing flat surfaces and beveled edges
- Featuring much more flexibility than normal dry pads making them ideal for concave & convex surfaces



Size	Code	Designed For	Grit	PK Qty
4"	PPD4-0050	Dry	50	10
4"	PPD4-0100	Dry	100	10
4"	PPD4-0200	Dry	200	10
4"	PPD4-0400	Dry	400	10
4"	PPD4-0800	Dry	800	10
4"	PPD4-1500	Dry	1500	10
4"	PPD4-3000	Dry	3000	10
4"	PPD4-B	Dry	BUFF	10
4"	PPD4-W	Dry	BUFF	10
4"	PPD4-Kit	Dry		5



Engineered Stone Polishing Pads

- The special diamond bond is designed to give longer life and a consistent factory finish.
- They work well on all quartz products.
- These pads, when used properly, will never burn or bleed into the material.
- They should always be run wet to prevent resin from burning.
- Recommended use is at 3000 rpm.

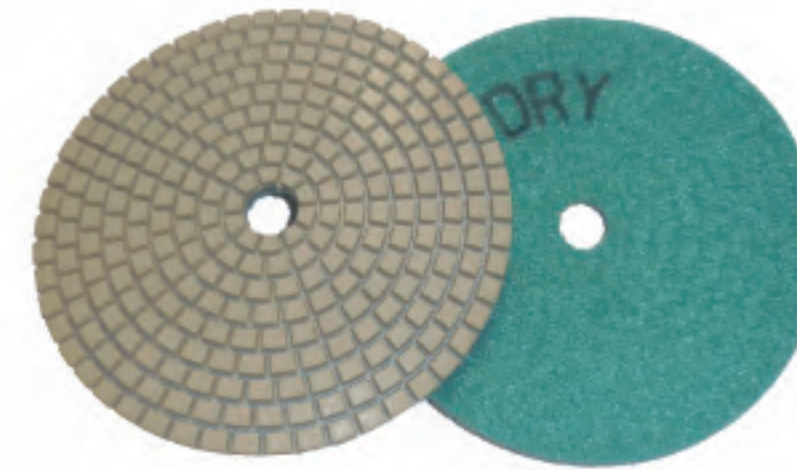

Size	Code	Designed For	Grit	PK Qty
4"	PPE4-0050	Dry	50	10
4"	PPE4-0100	Dry	100	10
4"	PPE4-0200	Dry	200	10
4"	PPE4-0400	Dry	400	10
4"	PPE4-0800	Dry	800	10
4"	PPE4-1500	Dry	1500	10
4"	PPE4-3000	Dry	3000	10

Felt Pad

Code	Size	PK Qty
FP4	4"	10
FP5	5"	10

- Ideal for polishing with powders
- White velcro on the back
- 3/8" thickness, Center hole 5/8"
- Domestic felt



5" Felt Pad

Code: **FP5-58**
Pk Qty: 5

- The ultimate pad for polishing natural stone





GRINDING AND ABRASIVE WHEELS

TILE CUTTERS

Sidewinder Variable Speed Angle Grinder

Code: **VT6858**

Pk Qty: **1**

- Compact 1200 watt motor
- Constant power motor increase output to 1320 watt as resistance is applied
- 4.5" Grinding disk
- Variable speed motor
- RPM 5000-12000



Variable Speed Wet Polisher

Code: **WG1600**

Pk Qty: **1**

- High Powered 1600 Watt Motor
- Adjustable water feed
- Variable speed motor
- RPM 1000-5500



Wet Grinder

Code: **WG110**

Pk Qty: **1**

- Professional grade
- Powerful 900W motor
- Disc diameter: 4" to 5"
- No-load speed: 500-4500RPM
- Heavy-duty components
- Wear resistant die-cast aluminium gear cover
- Crack resistant engineered nylon body
- Convenient spindle lock
- Lightweight and compact design
- Easy-to-change carbon brushes
- RPM 500-4500



Boss Pro Series Tile Cutter

- Rigid I-Beam for precision score and solid support when breaking tile or stone
- 4 position adjustable Titanium wheel scores the hardest of materials and lasts longer
- 6 piece bearing loaded handle with rubber grip for smooth accurate score
- Non-slip spring loaded rubber mat cutting table
- Adjustable support legs for large format tile and stone
- 45 degree angle guide

Replacement Wheel: BPRO - Wheel



BPRO-1240	48" Boss Pro Tile Cutter		
BPRO-1040	41" Boss Pro Tile Cutter		
BPRO-870	34.5" Boss Pro Tile Cutter		
BPRO-650	26" Boss Pro Tile Cutter		
BPRO-470	18" Boss Pro Tile Cutter		
BPRO-Wheel	Replacement Wheel		

Breaker Foot and Adjustable Wheel



6 Bearing Assembly



Breaking Point Window

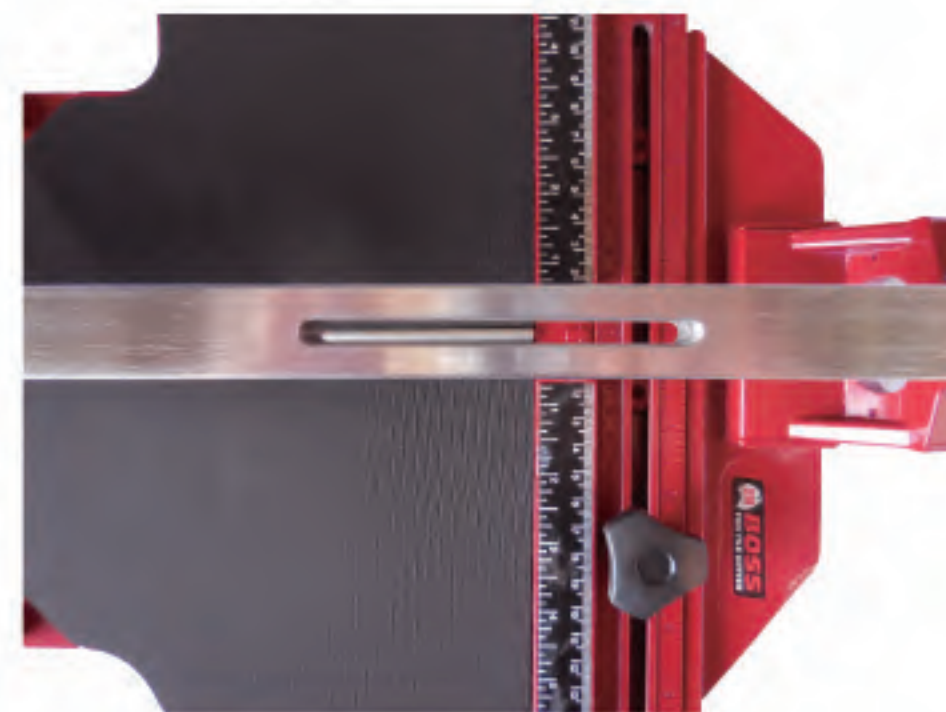

DTA Two Bar Tile Cutter 34"

Code: **RBC-860**

Pk Qty: 1

34" CUTTING CAPACITY

- Ideal for cutting large formats and materials of great hardness
- High performance single-point breaker
- Chromed and rectified steel guides, with anti-corrosion treatment
- Lateral stop for straight and 45 degree repetitive cutting
- Ergonomic shape and reinforced base
- Direct vision of the scoring and cutting line

Replacement Wheel: RBC-860SW

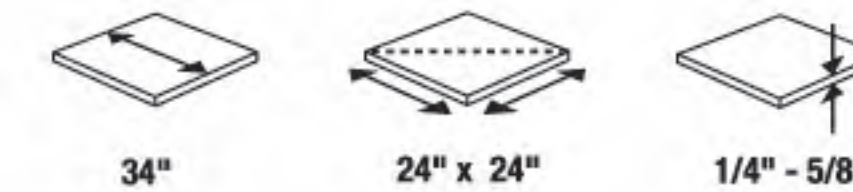

750mm / 30" Manual Tile Cutter

Code: **BTC-750**

Pk Qty: 1

30" CUTTING CAPACITY

- Die cast aluminium base
- 14mm / 9/16" max cutting depth
- Tungsten carbide wheel
- Suitable for ceramic porcelain wall and floor tiles

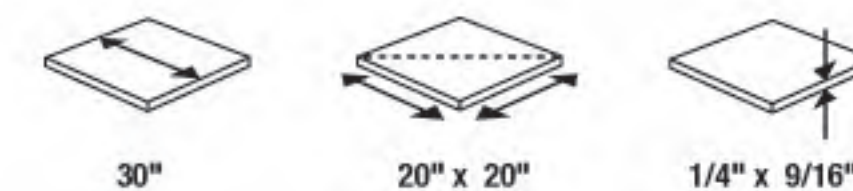

16" Handyman Tile Cutter

Code: **DTA-400**

Pk Qty: 6

16" CUTTING CAPACITY

- Push action wall and floor tile cutter
- Lightweight construction
- Steel base
- Polished dual rails

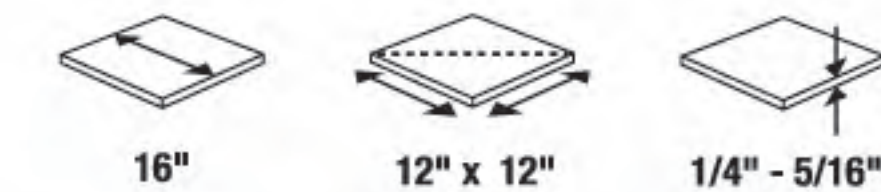

Code	Description
1 DTA-310SW	Replacement Wheel



950mm / 37" Manual Tile Cutter

Code: **BTC-950**

Pk Qty: 1

37" CUTTING CAPACITY

- Die cast aluminium base
- 14mm / 9/16" max cutting depth
- Tungsten carbide wheel
- Suitable for ceramic porcelain wall and floor tiles

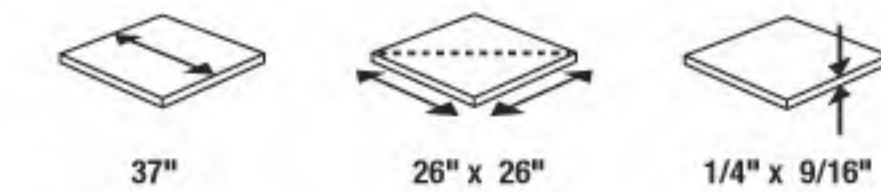



13" Handyman Tile Cutter

Code: DTA-330

Pk Qty: 6

13" CUTTING CAPACITY

- Push action wall tile cutter
- Lightweight construction
- Steel base
- Polished dual rails

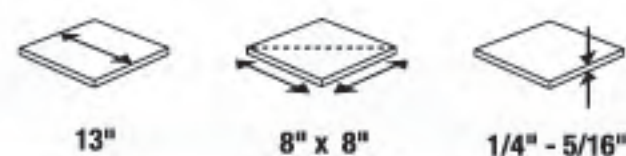

Code	Description
1 DTA-310SW	Replacement Wheel

24" DTA Tile Cutter

Code: DTA-600

Pk Qty: 4

24" CUTTING CAPACITY

- Solid 3/4" chrome dual rail
- Ball bearing sliding handle
- Tungsten carbide cutting wheel
- Heavy duty construction



Code	Description
1 DTA-600SW	Replacement Wheel
2 DTA-600G	Guide
3 DTA-600SH	Handle

12" Handyman Tile Cutter

Code: DTA-310

Pk Qty: 8

12" CUTTING CAPACITY

- Push action wall tile cutter
- Lightweight construction
- Steel base
- Polished dual rails

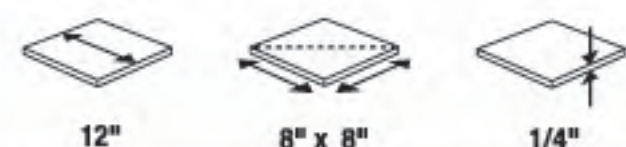

Code	Description
1 DTA-310SW	Replacement Wheel

Water Pump

Code: WPUMP.210

Pk Qty: 1

- Heavy duty constructing
- 210 gallons per hour



FORMAT TOOLS

FORMAT TOOLS

Carrier System

Code: LFCS

Pk Qty: 1

- Suitable to carry tile size upto 3.2 x 1.6m (126" x 63")
- Maximum load 130kg (286 lbs)
- 4 x 1800mm (71") poles and 2 x 1500mm (59") poles
- 6 x pump suction cups and 2 x aluminium suction cups all with protective covers
- 4 x soft grip handles
- Not including carry bag



Working Bench

Code: LFWB18012

Pk Qty: 1

- Sturdy and stable workbench for large format tiles
- Table size 1.8 x 1.4m (71" x 55")
- Maximum load 200kg (441 lbs)
- Aluminium construction
- Foldable legs
- Pulls apart for ease of storage and transport
- Can be assembled with additional bench for increased work surface



Working Bench

Code: LFWSC

Pk Qty: 1

- Carriage for transport and storage of all types of large format materials
- Suitable to display tile size upto 3.2 x 1.6m (126" x 63")
- Maximum load 280kg (617 lbs)
- Four steering wheels with brakes
- Hooks for carry frame



Manual Cutting System

Code: LFMTCS

Pk Qty: 1

- Suitable for tile size upto 3.2m (126")
- 3 piece rail system
- Professional carbide cutter Ø22 x Ø6 x 6
- Includes
 - Aluminium suction cup
 - Aluminium rail system
 - Tile nippers
 - Professional break nipper



Carbide Cutting Wheel

Code: LFMTCS-CCW22

Pk Qty: 1

- 6mm (1/4") diameter hole
- 2pcs pack
- Size 22mm (7/8")



Tile Gap Regulator

Code: LFTGR

Pk Qty: 1

- Ideal for shortening gaps between tiles and positioning
- and fine tuning of large format tiles
- Maximum horizontal tension up to 1200N
- 6 x aluminium suction cup can lift upto 150kg

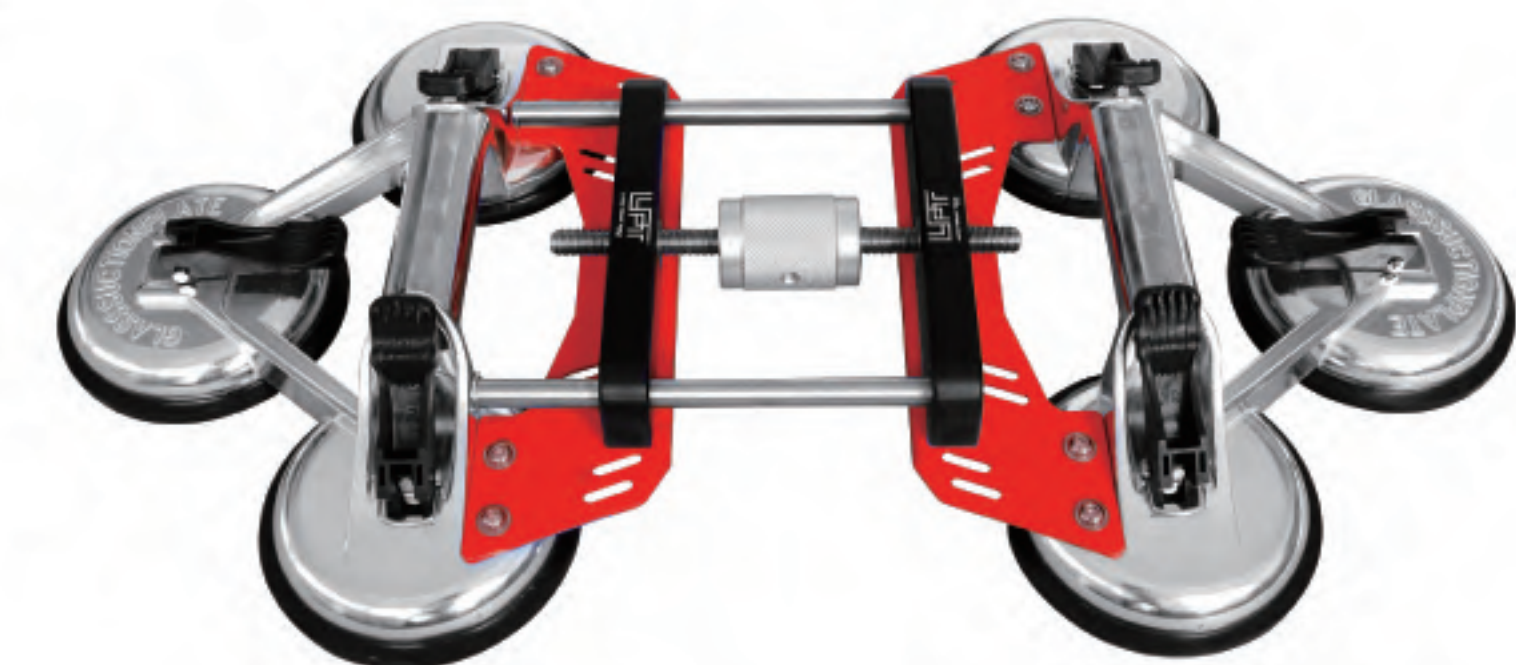



45° Diamond Grinding Head

Code: LFDGD88

Pk Qty: 1

- Dry/Wet
- Size: 87 x 15mm (7/8" x 7/8" high)
- Fine grit
- 45 degree grinding



Diamond Hand Pad

- For wet/ dry grinding edges and surface
- Suitable for tile, porcelain, marble and glass
- Size: 55 x 95mm (2-3/16" x 3-4/5")

Code	Size	QTY
DSP60	#60	10
DSP120	#120	10
DSP200	#200	10
DSP600	#600	10
DSP800	#800	10



Tile Beater

Code: LFTBB

Pk Qty: 1

- Eliminate air from underneath the tile
- Heavy duty rubber pad
- 355 x 146mm (14" x 5-4/5")



FORMAT TOOLS

FORMAT TOOLS



Stainless Steel FLOOR DRAINS

FLOOR DRAINS

FLOOR DRAINS COLLECTION

The DTA range of floor drains consists of two ranges, chrome brass floor drains and the stainless steel Hayman Collection. This stylish range of drains are easy to install and are available in a range of sizes and designs. Our large range of drains provides a solution for every shower and bathroom design.



FLOOR DRAINS

PVC Drain w/ Square Brushed Nickel Strainer - 12 Case

Code: DRBN3SQ

Pk Qty: 1

- The low profile design allows for installation in tight spaces.
- Drain body solvent welds over 2" or inside 3" Schedule 40 DWV pipe.
- Reversible clamping collar is secured with 4 stainless steel bolts into brass inserts.
- 2" IPS threaded strainer barrel is adjustable to allow for easy height adjustment.



PVC Drain w/ Round Stainless Steel Strainer - 12 Case

Code: DRSS3RD

Pk Qty: 1

- The low profile design allows for installation in tight spaces.
- Drain body solvent welds over 2" or inside 3" Schedule 40 DWV pipe.
- Reversible clamping collar is secured with 4 stainless steel bolts into brass inserts.
- 2" IPS threaded strainer barrel is adjustable to allow for easy height adjustment.



PVC Drain w/ Square Stainless Steel Strainer - 12 Case

Code: DRSS3SQ

Pk Qty: 1

- The low profile design allows for installation in tight spaces.
- Drain body solvent welds over 2" or inside 3" Schedule 40 DWV pipe.
- Reversible clamping collar is secured with 4 stainless steel bolts into brass inserts.
- 2" IPS threaded strainer barrel is adjustable to allow for easy height adjustment.



OUTLET LINEAR FLOOR DRAIN BASE

Code	Size	Pk Qty
FLD0600	24"	5
FLD0800	32"	5
FLD0900	36"	5
FLD1000	40"	5
FLD1200	48"	5



LINEAR FLOOR GRATE COVER

Code	Size	Pk Qty
FLDG0600	24"	10
FLDG0800	32"	10
FLDG0900	36"	10
FLDG1000	40"	10
FLDG1200	48"	10

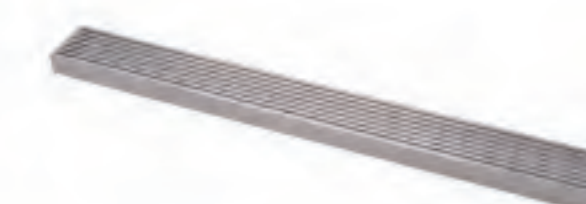

LINEAR FLOOR FLAT COVER

Code	Size	Pk Qty
FLDR0600	24"	10
FLDR0800	32"	10
FLDR0900	36"	10
FLDR1000	40"	10
FLDR1200	48"	10



LINEAR FLOOR TILE-IN COVER

Code	Size	Pk Qty
FLDT0600	24"	10
FLDT0800	32"	10
FLDT0900	36"	10
FLDT1000	40"	10
FLDT1200	48"	10



LINEAR DRAIN FRAME RUBBER

Code: FLD-RA

Pk Qty: 48



Weep Hole Protector

Code: WHP

Pk Qty: 25

- Protects weep holes from deck mud and mortar





PROFILE SELECTION



ALUMINIUM

Grade 6063T5 (Plain & Anodised)

Aluminium has a wide variety of applications and is sought after for its range of profiles and complex shapes. Aluminium is also lightweight, ductile and easy to cut and use. DTA offer many variants of finish, including bright and matt color anodising.



STAINLESS STEEL

Grade 304 and 316L (Marine Grade)

Ideal for coastal areas

Highly recommended for public and high traffic areas due to mechanical strength and chemical resistance. It is used in many architectural and technical applications.



BRASS

Grade C380

Brass is an elegant material and is highly regarded by architects and interior designers. It is best suited to indoor application and has a warm gold color.

HANDY HINT

Always remove excess grout immediately after grouting to avoid discolouration.



EDGE PROFILE

EDGE PROFILE

DTA Finishing Edge Profiles are designed to provide edge protection where tiles are bordered by carpet or timber, or as a decorative deging.

The DTA Finishing Profiles range adds a contemporary look, while still providing maximum tile protection.

Finish Edge Profiles are available in Aluminium, Brass and Stainless Steel finishes.

Aluminium L-Shape Edge Profile

- Aluminium angle for tile edge protection
- Used where tile meets carpet, wooden floors etc
- Creates an attractive finish if used on external corners

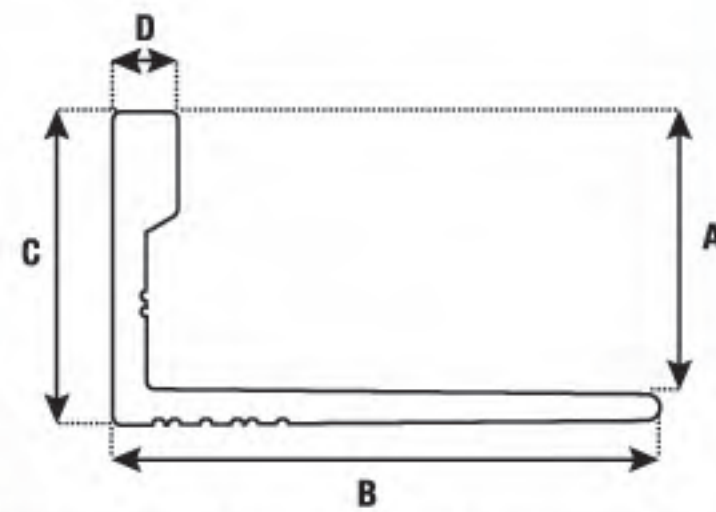

Size A	B	C	D
3/6"	53/64"	13/64"	3/32"
1/4"	53/64"	9/32"	3/32"
5/16"	53/64"	3/8"	3/32"
3/8"	53/64"	7/16"	3/32"
1/2"	53/64"	35/64"	3/32"

CHEMICAL CONTENT										
STANDARD	SILICONE (%)	IRON (%)	COPPER (%)	MANGANESE (%)	MAGNESIUM (%)	CHROMIUM (%)	ZINC (%)	TITANIUM (%)	OTHER (each 0.05%) (%)	ALUMINIUM (%)
(DIN/BS EN 573-3:1994) (DIN/BS EN 755-2:1997)	0.20-0.60	0.35	0.1	0.1	0.45-0.90	0.1	0.1	0.1	0.15	Rem
MECHANICAL PROPERTY										
STANDARD	DIMENSION (mm)	0.2% Proof Stress minimum (N/mm ²)	Tensile Strength minimum (N/mm ²)	Elongation (%)	Elongation on 50mm (%)					
(DIN/BS EN 573-3:1994) (DIN/BS EN 755-2:1997)	<3	130	175	8	6					
	3-8-25	110	160	7	5					

Length: 8'		3/6"	1/4"	5/16"	3/8"	1/2"	Pk Qty
Color	Code	Code	Code	Code	Code	Code	
	ALA8.04MS	ALA8.06MS	ALA8.08MS	ALA8.10MS	ALA8.12MS		20
	ALA8.04BFS	ALA8.06BFS	ALA8.08BFS	ALA8.10BFS	ALA8.12BFS		20
	ALA8.04BS	ALA8.06BS	ALA8.08BS	ALA8.10BS	ALA8.12BS		20
	ALA8.04BFB	ALA8.06BFB	ALA8.08BFB	ALA8.10BFB	ALA8.12BFB		20
	ALA8.04N	ALA8.06N	ALA8.08N	ALA8.10N	ALA8.12N		20
		ALA8.06BK	ALA8.08BK	ALA8.10BK	ALA8.12BK		20
		ALA8.06W	ALA8.08W	ALA8.10W	ALA8.12W		20
				ALA8.10DB	ALA8.12DB		20
		ALA8.06FBK	ALA8.08FBK	ALA8.10FBK	ALA8.12FBK		20
				ALA8.10G	ALA8.12G		20

Stainless Steel L-Shape Profile

- Stainless Steel L-shape angle available in 8' lengths.
- Creates an elegant decorative finish for: stairs, external corners both horizontal and vertical, transition between carpet and tile and finishing profile on a wall
- Available in 304 grade Stainless Steel

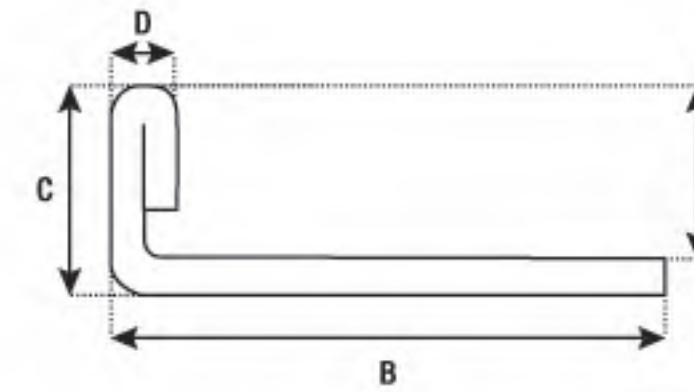

Size A	B	C	D
5/16"	1.1"	5/16"	3/32"
3/8"	1.1"	3/8"	3/32"
1/2"	1.1"	1/2"	3/32"

CHEMICAL CONTENT								
STANDARD	LEAD (%)	CADMIUM (%)	ARSENIC (%)	ANTIMONY (%)	BARIUM (%)	MERCURY (%)	SELENIUM (%)	CHROMIUM (%)
AS15	5.0	1.0	1.0	1.0	5.0	1.0	1.0	1.0
MECHANICAL PROPERTY								
STANDARD	Tensile Strength minimum (N/mm ²)				Elongation (%)			
AS15	508.6				127			

Length: 8'	5/16"	3/8"	1/2"	Pk Qty
Color	Code	Code	Code	
	SSE8.08304	SSE8.10304	SSE8.12304	20

Chrome Brass L-Shape Edge Profile



- Chrome Brass L-Shape edge profile is available in 8' lengths.
- Creates an attractive finish if used on external corners
- Used where tile meets carpet, wooden floors etc.
- Designed for tile edge protection

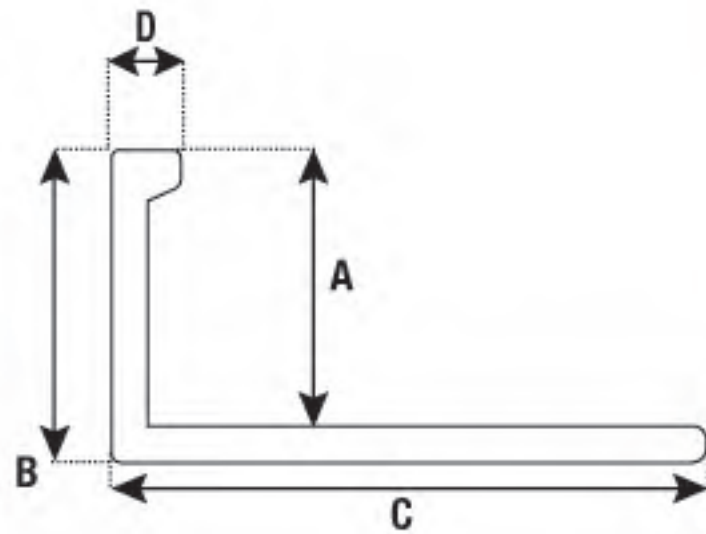

Size A	B	C	D
3/8"	7/16"	7/8"	3/32"
1/2"	9/16"	7/8"	3/32"

Length: 8'		3/8"	1/2"	Pk Qty
Color		Code	Code	
	Chrome	BCL8.10	BCL8.12	20

Aluminium Contempo Edge Profile



- Aluminium Contempo profile for tile protection
- Ideal for: external corners both vertical and horizontal, transition between carpet and tile and finishing profile on a vertical wall
- Decorative profile to create an elegant look

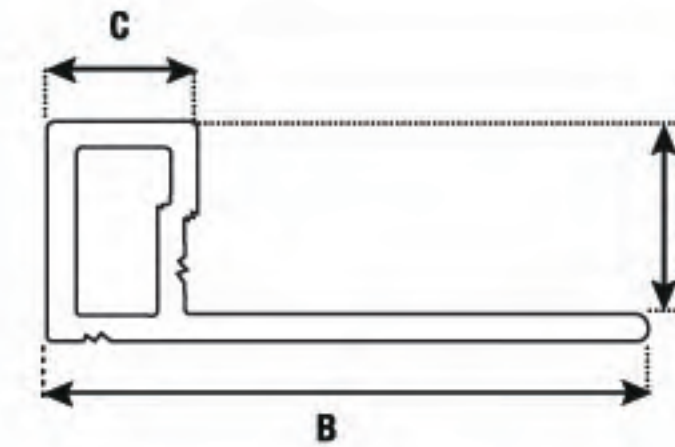

Size A	B	C
5/16"	1-1/16"	1/4"
3/8"	1-1/16"	1/4"
1/2"	1-1/16"	1/4"

Length: 8'		5/16"	3/8"	1/2"	Pk Qty
Color		Code	Code	Code	
	Matt Silver	ACL8.08MS	ACL8.10MS	ACL8.12MS	20
	Brush Finish	ACL8.08BFS	ACL8.10BFS	ACL8.12BFS	20
	Bright Silver	ACL8.08BS	ACL8.10BS	ACL8.12BS	20
	Nickel	ACL8.08N	ACL8.10N	ACL8.12N	20

Corners		5/16"	3/8"	1/2"	Pk Qty
Color		Code	Code	Code	
	Matt Silver	ACL8.08MS	ACL8.10MS	ACL8.12MS	20
	Brush Finish	ACL8.08BFS	ACL8.10BFS	ACL8.12BFS	20
	Bright Silver	ACL8.08BS	ACL8.10BS	ACL8.12BS	20
	Nickel	ACL8.08N	ACL8.10N	ACL8.12N	20

ALLOY: 6063 TEMPER: T5

CHEMICAL CONTENT										
STANDARD	SILICONE (%)	IRON (%)	COPPER (%)	MANGANESE (%)	MAGNESIUM (%)	CHROMIUM (%)	ZINC (%)	TITANIUM (%)	OTHER (each 0.00%) (%)	ALUMINIUM (%)
(DIN/BS EN 573-3:1994) (DIN/BS EN 755-2:1997)	0.20-0.80	0.35	0.1	0.1	0.45-0.90	0.1	0.1	0.1	0.15	Rem

MECHANICAL PROPERTY					
STANDARD	DIMENSION (mm)	0.2% Proof Stress minimum (N/mm ²)	Tensile Strength minimum (N/mm ²)	Elongation (%)	Elongation on 50mm (%)
(DIN/BS EN 573-3:1994) (DIN/BS EN 755-2:1997)	<=3	130	175	8	6
	3<=25	110	160	7	5

Chrome Brass Contempo Edge Profile



- Ideal for: external corners both vertical and horizontal, transition between carpet and tile and finishing profile on a vertical wall

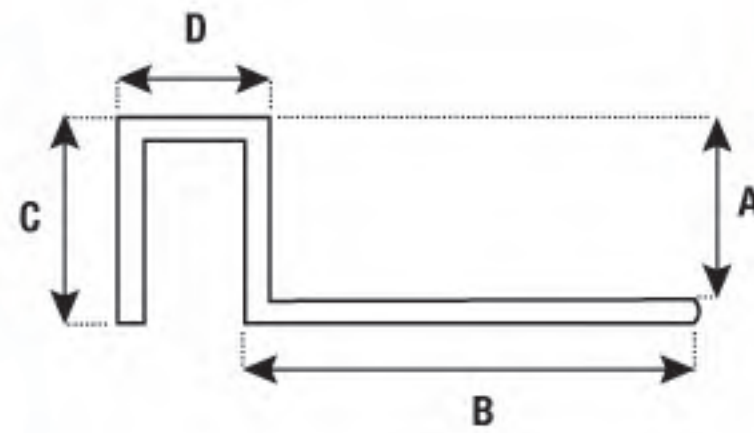

Size A	B	C	D
3/8"	3/4"	7/16"	17/64"
1/2"	3/4"	9/16"	17/64"

CHEMICAL CONTENT								
STANDARD	COPPER (%)	IRON (%)	LEAD (%)	MANGANESE (%)	TIN (%)	NICKEL (%)	ALUMINUM (%)	ZINC (%)
AS1567	57.2	0.3	2.17	0.01	0.39	0.19	0.45	Rem.
MECHANICAL PROPERTY								
STANDARD	Tensile Strength minimum (N/mm ²)				Elongation (%)			
AS1567	64.38				12			

Color	3/8"		1/2"		Pk Qty
	Code		Code		
	Chrome Brass	BCC8.10	BCC8.12		20

Aluminium Square Edge Profile



- Square finish profile for tile protection
- Ideal for: external corners both vertical and horizontal, transition between carpet and tile and finishing profile on a vertical wall
- Decorative profile to create an elegant look

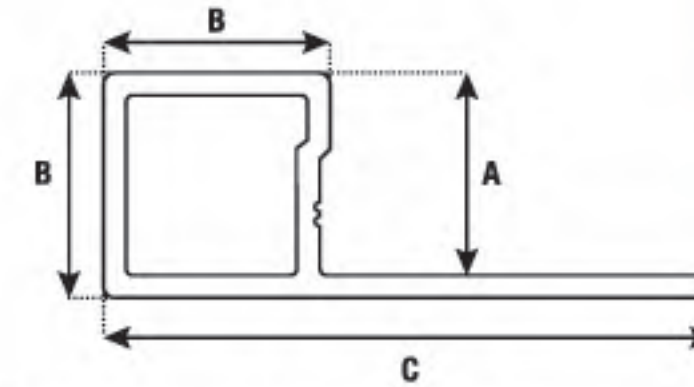

Size A	B	C
1/4"	5/6"	1-3/32"
5/16"	3/8"	1-11/64"
3/8"	15/32"	1-1/4"
1/2"	35/64"	1-21/64"

CHEMICAL CONTENT										
STANDARD	SILICONE (%)	IRON (%)	COPPER (%)	MANGANESE (%)	MAGNESIUM (%)	CHROMIUM (%)	ZINC (%)	TITANIUM (%)	OTHER (each 0.05%) (%)	ALUMINUM (%)
(DIN/ISO EN 573-3:1994 (DIN/ISO EN 755-2:1997)	0.25-0.60	0.35	0.1	0.1	0.45-0.90	0.1	0.1	0.1	0.15	Rem.
MECHANICAL PROPERTY										
STANDARD	DIMENSION (mm)	0.2% Proof Stress minimum (N/mm ²)	Tensile Strength minimum (N/mm ²)	Elongation (%)	Elongation on 50mm (%)					
(DIN/ISO EN 573-3:1994 (DIN/ISO EN 755-2:1997)	<=3 3<e<=25	130 110	175 160	8 7	6 5					

Color	1/4"		5/16"		3/8"		1/2"		Pk Qty
	Code		Code		Code		Code		
	Matt Silver	ASQS8.06MS	ASQS8.08MS	ASQS8.10MS	ASQS8.12MS				20
	Brush Finish	ASQS8.06BFS	ASQS8.08BFS	ASQS8.10BFS	ASQS8.12BFS				20
	Bright Silver	ASQS8.06BS	ASQS8.08BS	ASQS8.10BS	ASQS8.12BS				20
	Nickel	ASQS8.06N	ASQS8.08N	ASQS8.10N	ASQS8.12N				20

Square Edge Corners

Color	1/4"		5/16"		3/8"		1/2"		Pk Qty
	Code		Code		Code		Code		
	Matt Silver	ASQEC06MS	ASQEC08MS	ASQEC10MS	ASQEC12MS				10
	Brush Finish	ASQEC06BFS	ASQEC08BFS	ASQEC10BFS	ASQEC12BFS				10
	Bright Silver	ASQEC06BS	ASQEC08BS	ASQEC10BS	ASQEC12BS				10
	Nickel	ASQEC06N	ASQEC08N	ASQEC10N	ASQEC12N				10



Stainless Steel Square Edge Profile



- Stainless Steel square edge is available in 8' lengths.
- Creates an elegant decorative finish for: stairs, external corners both horizontal and vertical, transition between carpet and tile and finishing profile on a wall
- Available in 304 grade Stainless Steel

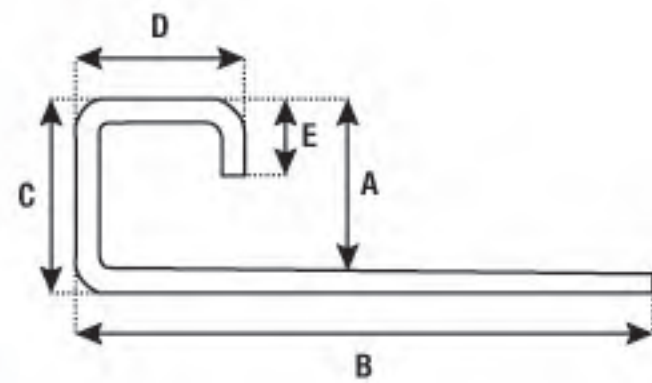

Size A	B	C	D
3/8"	1.1"	5/16"	3/16"
1/2"	1.1"	3/8"	1/4"

CHEMICAL CONTENT								
STANDARD	LEAD (%)	CADMIUM (%)	ARSENIC (%)	ANTIMONY (%)	BARIUM (%)	MERCURY (%)	SELENIUM (%)	CHROMIUM (%)
AS15	5.0	1.0	1.0	1.0	5.0	1.0	1.0	1.0
MECHANICAL PROPERTY								
STANDARD	Tensile Strength minimum (N/mm ²)				Elongation (%)			
AS15	506.6				127			

Length: 8'		3/8"	1/2"	Pk Qty
Color		Code	Code	
	Stainless Steel (304 Grade)	SSQ8.10304	SSQ8.12304	20



Aluminium Round Edge Profile



- Semi-quadrant finish for tile edge protection
- Designed for wall and external corner applications
- Creates an elegant look

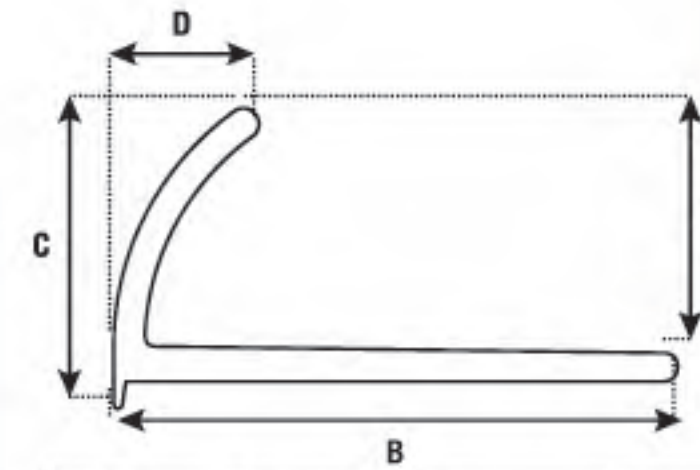

Size A	B	C	D
1/4"	7/8"	11/32"	11/64"
5/16"	7/8"	13/32"	1/4"
3/8"	29/32"	1/2"	1/4"
1/2"	29/32"	5/8"	1/4"

ALLOY: 6063 TEMPER: T5										
CHEMICAL CONTENT										
STANDARD	SILICONE (%)	IRON (%)	COPPER (%)	MANGANESE (%)	MAGNESIUM (%)	CHROMIUM (%)	ZINC (%)	TITANIUM (%)	OTHER (each 0.05% (%))	ALUMINIUM (%)
DIN/BS EN 573-3:1994 DIN/BS EN 755-2:1997	0.20-0.60	0.35	0.1	0.1	0.45-0.90	0.1	0.1	0.1	0.15	Rem
MECHANICAL PROPERTY										
STANDARD	DIMENSION (mm)	0.2% Proof Stress minimum (N/mm ²)	Tensile Strength minimum (N/mm ²)	Elongation (%)	Elongation on 50mm (%)					
DIN/BS EN 573-3:1994 DIN/BS EN 755-2:1997	<=3 3>8<-25	130 110	175 160	8 7	6 5					

Length: 8'		1/4"	5/16"	3/8"	1/2"	Pk Qty
Color		Code	Code	Code	Code	
	Matt Silver	ARE8.06MS	ARE8.08MS	ARE8.10MS	ARE8.12MS	20
	Brush Finish	ARE8.06BFS	ARE8.08BFS	ARE8.10BFS	ARE8.12BFS	20
	Bright Silver	ARE8.06BS	ARE8.08BS	ARE8.10BS	ARE8.12BS	20
	Bright Bronze	ARE8.06BB	ARE8.08BB	ARE8.10BB	ARE8.12BB	20
	Nickel	ARE8.06N	ARE8.08N	ARE8.10N	ARE8.12N	20
	Gloss Black		ARE8.08BK	ARE8.10BK	ARE8.12BK	20
	White		ARE8.08W	ARE8.10W	ARE8.12W	20

Round Edge Corners		1/4"	5/16"	3/8"	1/2"	Pk Qty
Color		Code	Code	Code	Code	
	Matt Silver	AREC06MS	AREC08MS	AREC10MS	AREC12MS	10
	Brush Finish	AREC06BFS	AREC08BFS	AREC10BFS	AREC12BFS	10
	Bright Silver	AREC06BS	AREC08BS	AREC10BS	AREC12BS	10
	Nickel	AREC06N	AREC08N	AREC10N	AREC12N	10



Stainless Steel Round Edge Profile



- Stainless Steel semi-quadrant round edge creates an elegant decorative external corner
- Can be used on: stairs, bath hobs, external corners both horizontal or vertical and finishing profile on a wall
- Available in 304 grade Stainless Steel

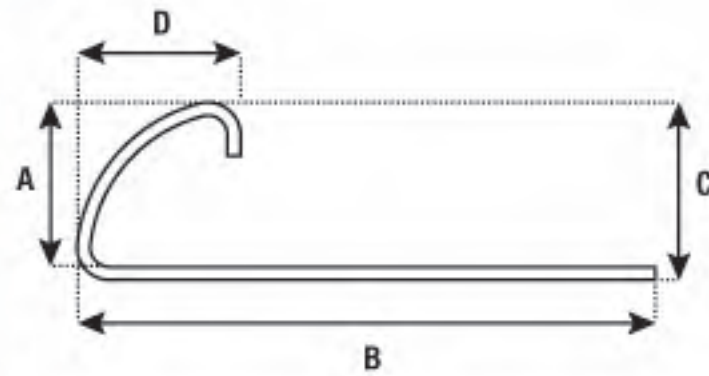

Size A	B	C	D
3/8"	1.1"	3/8"	1/4"
1/2"	1.1"	1/2"	1/4"

CHEMICAL CONTENT								
STANDARD	LEAD (%)	CADMIUM (%)	ARSENIC (%)	ANTIMONY (%)	BARIUM (%)	MERCURY (%)	SELENIUM (%)	CHROMIUM (%)
AS15	5.0	1.0	1.0	1.0	5.0	1.0	1.0	1.0
MECHANICAL PROPERTY								
STANDARD	Tensile Strength minimum (N/mm ²)				Elongation (%)			
AS15	506.5				127			

Length: 8'

Color	3/8"	1/2"	Pk Qty
Stainless Steel (304 Grade)	Code SSRE8.10304	Code SSRE8.12304	20



TRANSITION PROFILE

DTA Transition Profiles are designed to provide a smooth transition between tile and floor coverings or finished concrete at lower elevations. They are also designed to provide a smooth transition between two different materials of the same height.

EDGE PROFILE

TRANSITION PROFILE

Aluminium Transition Edge Profile



- Transition Step edge available in 8' foot lengths
- Incline allows for a gradual transition from either concrete, wood floor or vinyl to protect the edge of the tile
- Ideal for domestic or commercial application
- 1/2" profile has a support leg for extra strength



Transition Profile

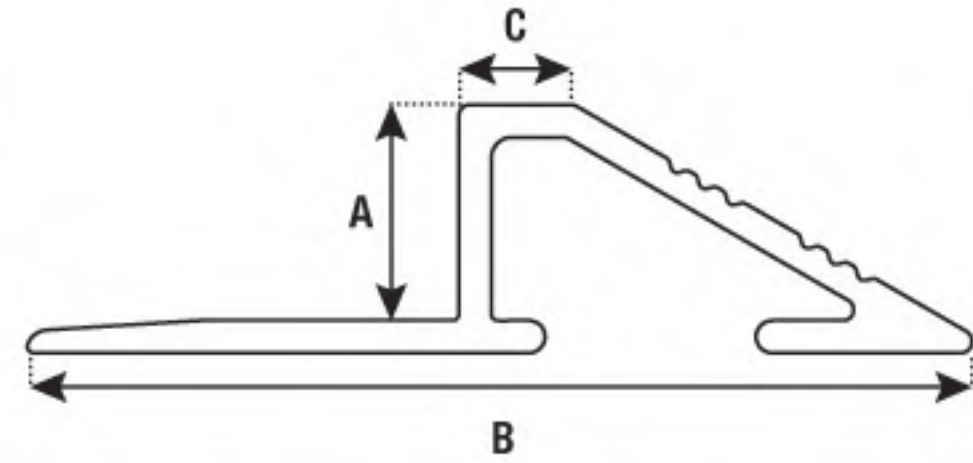

Size A	B	C
5/16"	1.5"	1/4"
3/8"	1.6"	1/4"

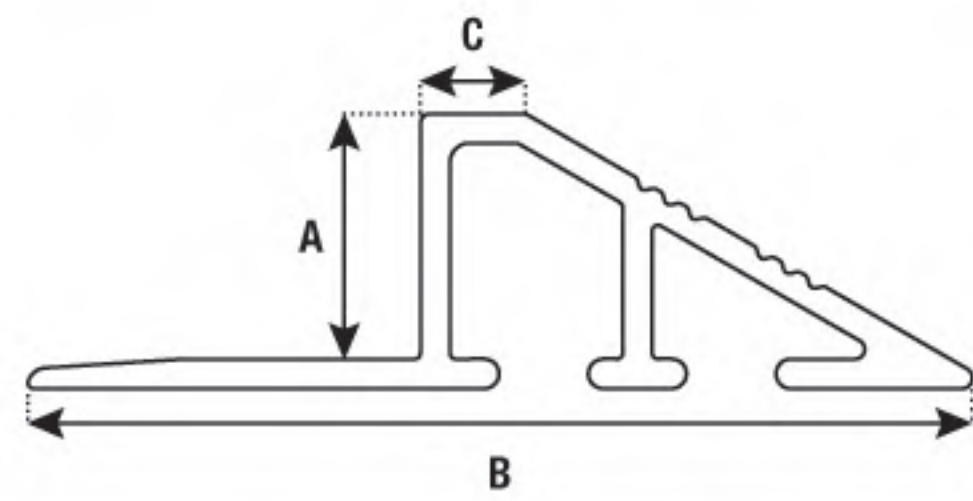

Size A	B	C
1/2"	1.9"	1/4"

ALLOY: 6063 TEMPER: T5

CHEMICAL CONTENT										
STANDARD	SILICONE (%)	IRON (%)	COPPER (%)	MANGANESE (%)	MAGNESIUM (%)	CHROMIUM (%)	ZINC (%)	TITANIUM (%)	OTHER (each 0.05%) (%)	ALUMINIUM (%)
(DIN/BS) EN 573-3:1994 (DIN/BS) EN 755-2:1997	0.20-0.60	0.35	0.1	0.1	0.45-0.90	0.1	0.1	0.1	0.15	Rem

MECHANICAL PROPERTY					
STANDARD	DIMENSION (mm)	0.2% Proof Stress minimum (N/mm ²)	Tensile Strength minimum (N/mm ²)	Elongation (%)	Elongation on 50mm (%)
(DIN/BS) EN 573-3:1994 (DIN/BS) EN 755-2:1997	<=3	130	175	8	6
	3<e<=25	110	160	7	5

Length: 8'		5/16"	3/8"	1/2"	Pk Qty
Color	Code	Code	Code		
Plain	ATSE8.08	ATSE8.10	ATSE8.12	10	
Matt Silver	ATSE8.08MS	ATSE8.10MS	ATSE8.12MS	10	
Bright Silver	ATSE8.08BS	ATSE8.10BS	ATSE8.12BS	10	

Aluminium Dividing Profile



- The dividing profile is designed to provide transitions between existing same-height, hard-surface floor coverings
- Applications include ceramic tile or natural stone, parquet flooring, concrete pavers, laminate etc.
- Primarily used in retrofit applications

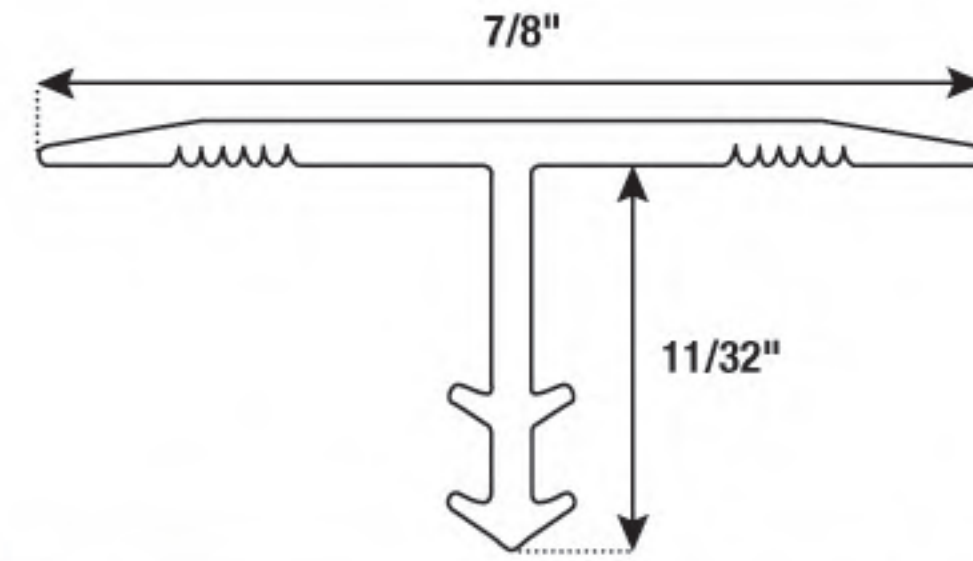
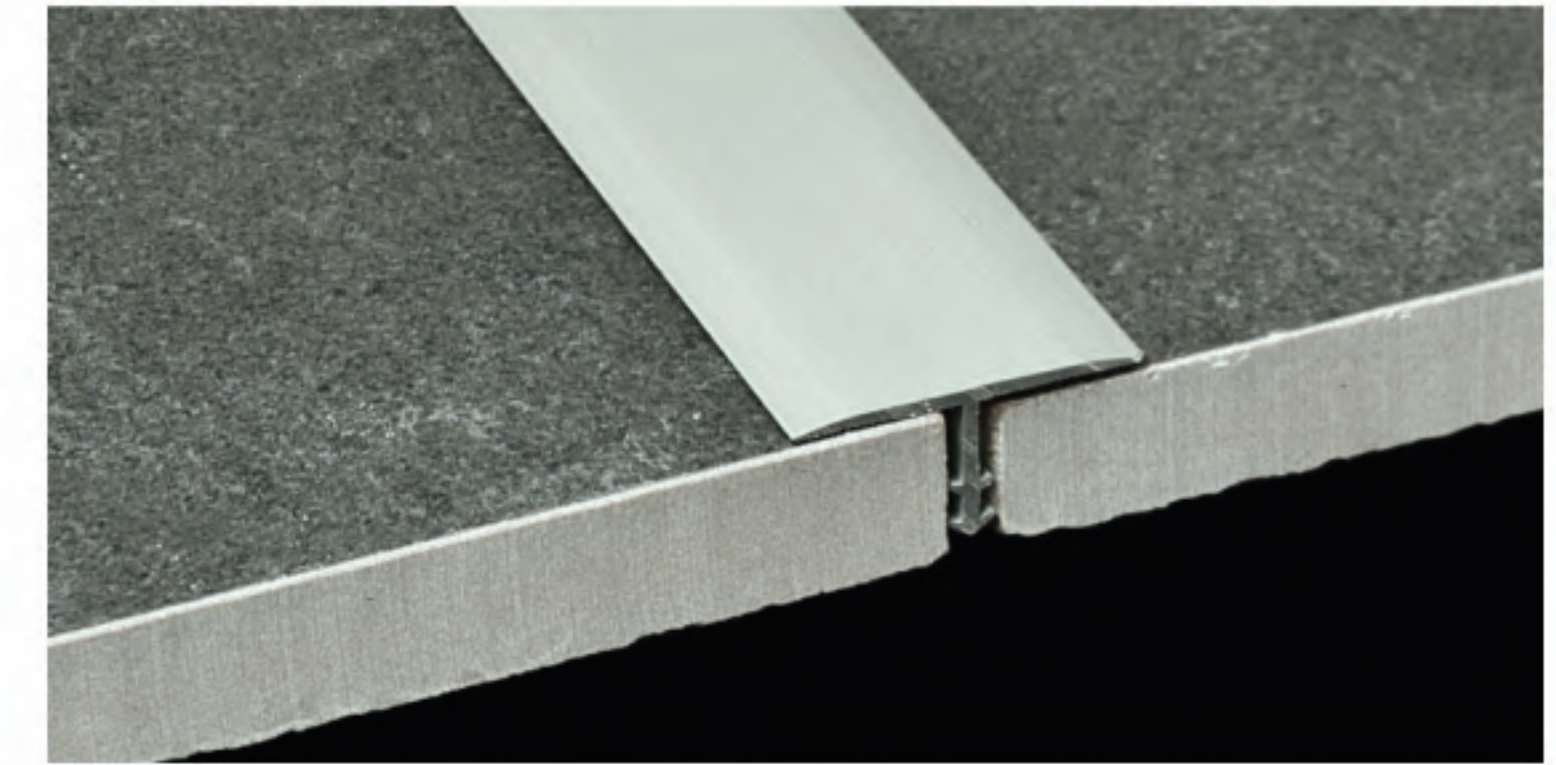

ALLOY: 6063 TEMPER: T5

CHEMICAL CONTENT										
STANDARD	SILICONE (%)	IRON (%)	COPPER (%)	MANGANESE (%)	MAGNESIUM (%)	CHROMIUM (%)	ZINC (%)	TITANIUM (%)	OTHER (each 0.05%) (%)	ALUMINIUM (%)
(DIN/BS) EN 573-3:1994 (DIN/BS) EN 755-2:1997	0.20-0.60	0.35	0.1	0.1	0.45-0.90	0.1	0.1	0.1	0.15	Rem

MECHANICAL PROPERTY					
STANDARD	DIMENSION (mm)	0.2% Proof Stress minimum (N/mm ²)	Tensile Strength minimum (N/mm ²)	Elongation (%)	Elongation on 50mm (%)
(DIN/BS) EN 573-3:1994 (DIN/BS) EN 755-2:1997	<=3	130	175	8	6
	3<e<=25	110	160	7	5

Color	Size	Code	Pk Qty
Matt Silver	7/8" x 3/8"	ADS8.22MS	10
Nickel	7/8" x 3/8"	ADS8-22N	10
Black	7/8" x 3/8"	ADS8-22BFBK	10
Dark Bronze	7/8" x 3/8"	ADS8-22DB	10

Aluminium Transition Edge Profile



- Transition Step edge available in 8' 2-1/2" foot lengths
- Incline allows for a gradual transition from either concrete, wood floor or vinyl to protect the edge of the tile
- Ideal for residential or commercial application

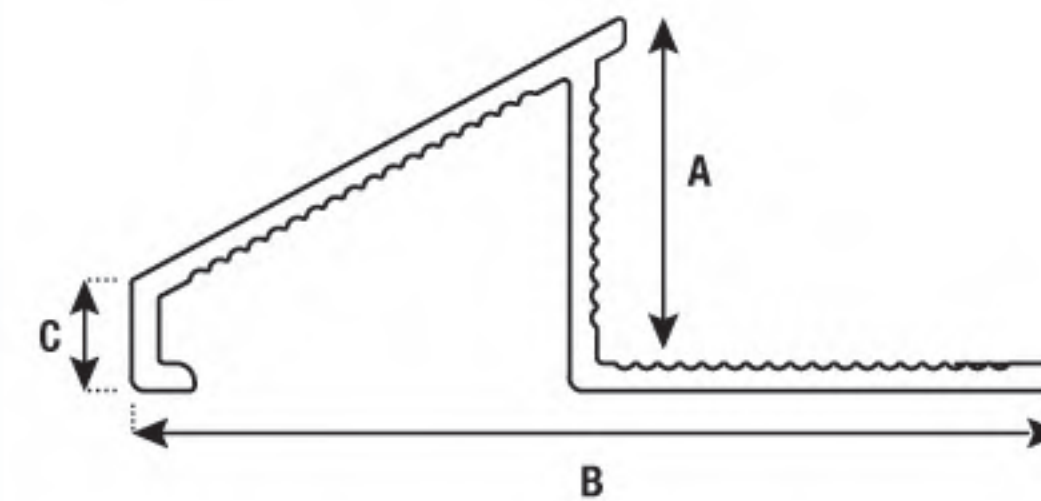
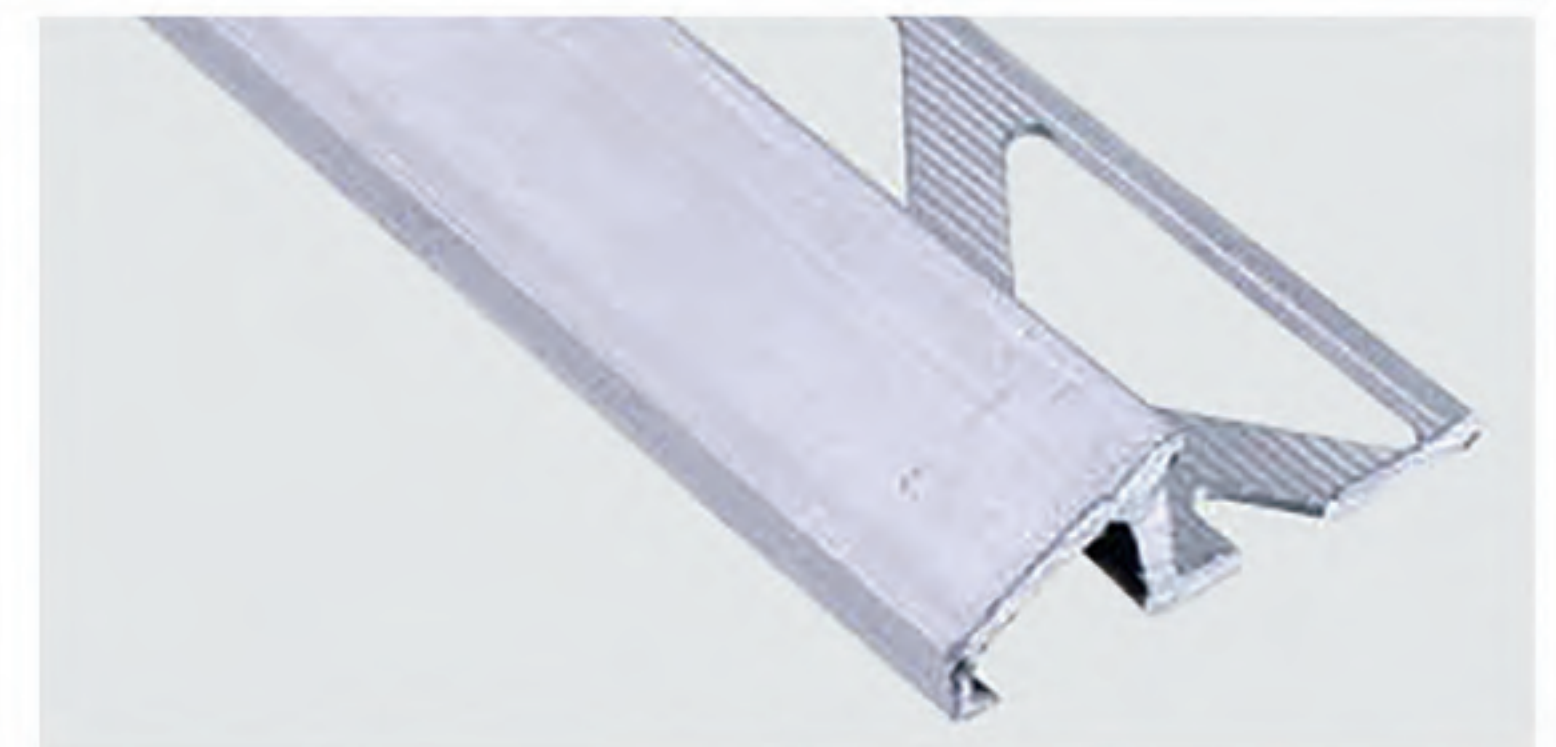

Size A	B	C
3/8"	1-1/2"	5/32"
1/2"	1-5/8"	5/32"

ALLOY: 6063 TEMPER: T5

CHEMICAL CONTENT										
STANDARD	SILICONE (%)	IRON (%)	COPPER (%)	MANGANESE (%)	MAGNESIUM (%)	CHROMIUM (%)	ZINC (%)	TITANIUM (%)	OTHER (each 0.05%) (%)	ALUMINIUM (%)
(DIN/BS) EN 573-3:1994 (DIN/BS) EN 755-2:1997	0.20-0.60	0.35	0.1	0.1	0.45-0.90	0.1	0.1	0.1	0.15	Rem

MECHANICAL PROPERTY					
STANDARD	DIMENSION (mm)	0.2% Proof Stress minimum (N/mm ²)	Tensile Strength minimum (N/mm ²)	Elongation (%)	Elongation on 50mm (%)
(DIN/BS) EN 573-3:1994 (DIN/BS) EN 755-2:1997	<=3	130	175	8	6
	3<e<=25	110	160	7	5

Length: 8'		3/8"	1/2"	Pk Qty
Color	Code	Code		
Matt Silver	ATE8.10MS	ATE8.12MS	10	



Tool Merchandising Stand

DIMENSIONS - 40"(W) x 79" (H)

- Neatly and conveniently displays tools in stores
- Can be individually tailored to suit store requirements



Product	Code	Pk Qty
Tool Stand	DTATD	1
Shelf for Stand	DTATDS	1
6" Peg Board Hook with Flipper Tag	PBH200	1
10" Peg Board Hook with Flipper Tag	PBH250	1

Profile Merchandising Stand

DIMENSIONS - 40"(W) x 79" (H)

- Neatly and efficiently displays PVC and metal trims in stores
- Can be individually tailored to suit store requirements

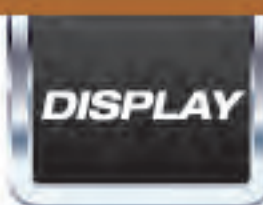

Product	Code	Pk Qty
Profile Stand	DTATD	1
Profile Divider Brackets	DTATDHT	1

Brochures



Catalogues

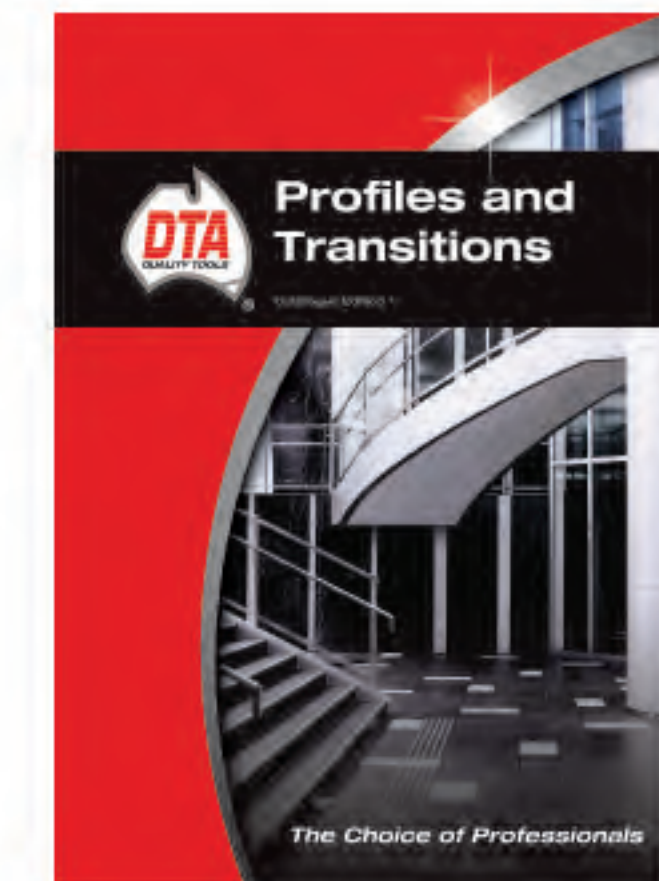
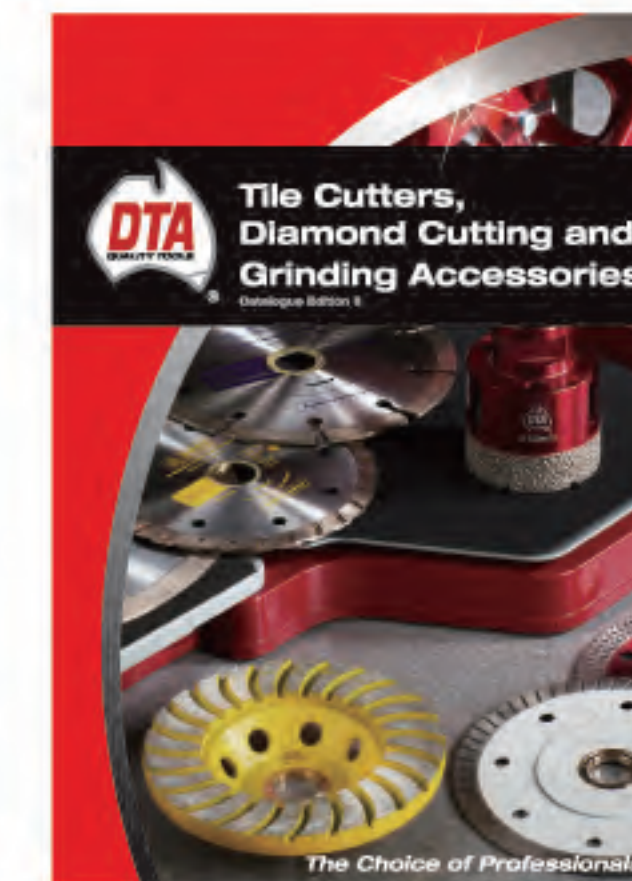

DTA Poster Boards

- 35" x 24"
- Available in 6 designs



Product	Code	Pk Qty
We Proudly Recommend DTA	DTAPB01	1
Revolutionary Tools Smooth Result	DTAPB02	1
Handy Tools Precision Perfect	DTAPB03	1
Quality Tools Floorless Finish	DTAPB04	1
Lippage Levelling System	DTAPB05	1
Hayman Drains	DTAPB06	1

